

User Manual

V Series and VL Series

In order to prevent improper operation before use, please read this manual carefully.

Content

1. Notes on This Manual	3
1.1 Scope of Validity	3
1.2 Target Group	3
1.3 Symbols Used	3
1.4 Symbols Explanation	3
2. Safety Precautions	5
2.1 Unpacking and Inspection	5
2.2 Package Safety	5
2.3 Electrical Connection Safety	6
2.4 Operation Safety	7
2.5 Maintenance Safety	7
2.6 Disposal Safety	8
3. Introduction	9
3.1 Product Introduction	9
3.2 Basic Features	10
3.3 Size	10
3.4 LED Indicator Panel	10
3.5 Terminals of Inverter	11
3.6 Circuit Diagram	12
3.7 AFCI Function (Optional)	13
3.7.1 Function Introduction	13
3.7.2 Alarm Clear	13
3.7.3 AFCI Protection Configuration	15
4. Technical Parameters	16
4.1 DC Input/AC Output for V Series	16
4.2 DC Input/AC Output for VL Series	18
4.3 Efficiency, Protection, and Safety	19
4.4 General Data	20
5. Installation	21
5.1 Installation Safety	21
5.2 Check for Physical Damage	21
5.3 Packing List	21
5.4 Mounting	22
5.4.1 Environment Requirement	22
5.4.2 Space Requirement	23
5.4.3 Angle Requirement	23
5.4.4 Installation Steps	24
6. Electrical Connection	28
6.1 Safety Precautions	28
6.2 Electrical Connection Overview	28
6.3 Secondary Ground Connection	29
6.4 AC Wiring	30
6.4.1 AC Wiring Requirements	30

6.4.2 Wiring Steps	31
6.4.3 Aluminum Cable Requirements	32
6.5 DC Connection	33
6.5.1 PV Input Configuration	34
6.5.2 Assembling DC Connectors	36
6.5.3 DC Wiring	37
6.6 Communication Device Installation	38
6.6.1 Communication Connector Wiring Steps	38
6.6.2 Wire Sequence of the Rubber Core	40
6.6.3 Ripple Control (Optional)	40
6.6.4 Monitoring Module (Optional)	41
6.6.5 Communication Connector Application Method	41
7. Commissioning	45
7.1 Inspection before Commissioning	45
7.2 Inverter Start-Up	45
7.3 Inverter Switch Off	45
7.4 Fox Cloud APP	45
8. Maintenance	47
8.1 Maintenance Safety	47
8.2 Alarm List	48
8.3 Troubleshooting	56
8.4 Routine Maintenance	56
9. Decommissioning	58
9.1 Dismantling the Inverter	58
9.2 Packaging	58
9.3 Storage and Transportation	58

1. Notes on This Manual

1.1 Scope of Validity

This manual describes the assembly, installation, commissioning, maintenance and troubleshooting of the following models of Fox ESS products:





V30, V33, V36, V40, V50, V60, V75, VL15, VL20, VL25, VL30, VL37.5

1.2 Target Group

This manual is for qualified electricians. The tasks described in this manual only can be performed by qualified electricians.



1.3 Symbols Used





This section explains the symbols shown on the inverter and on the type label:

	Danger! "Danger" indicates a hazardous situation which, if not avoided, will result in death or serious injury.
	Warning! "Warning" indicates a hazardous situation which, if not avoided, could result in death or serious injury.
	Caution! "Caution" indicates a hazardous situation which, if not avoided, could result in minor or moderate injury.
	Note! "Note" provides important tips and guidance.

1.4 Symbols Explanation



This section explains the symbols shown on the inverter and on the type label:

Symbols	Explanation
	CE mark. The inverter complies with the requirements of the applicable CE guidelines.
	Beware of hot surface. The inverter can become hot during operation. Avoid contact during operation.
	Danger of high voltages. Disconnect from the grid and the PV generator before opening the device.

	<p>Danger. Risk of electric shock!</p>
	<p>Danger to life due to high voltage. There is residual voltage in the inverter which needs 15 min to discharge. Wait 15 min before you open the cover.</p>
	<p>Read the manual.</p>
	<p>Product should not be disposed as household waste.</p>
	<p>This mark indicates that the product meets EU environment protection certification requirements.</p>

2. Safety Precautions

This series inverter is designed and tested in accordance with international safety requirements. However, certain safety precautions must be taken into account when installing and operating this inverter. The installer must read and follow all instructions, cautions, and warnings in this installation manual.



	<p>Warning!</p> <ul style="list-style-type: none">• It is strictly prohibited to operate the product (including, but not limited to, handling, installation, electrical connection, powering up, maintenance, working at height, etc.) in bad weather, such as thunder, lightning, rain, snow, or winds of more than force six grades.• In case of fire, evacuate the building or product area and call the fire alarm. In any case, re-entry into the burning area is strictly prohibited.
	<p>Note!</p> <ul style="list-style-type: none">• All operations including transport, installation, start-up, and maintenance, must be carried out by qualified, trained personnel.• The electrical installation & maintenance of the inverter shall be conducted by a licensed electrician and shall comply with local wiring rules and regulations.• Please operate the equipment under the condition that you are familiar with and understand the contents of this manual and have the appropriate tools.• The photovoltaic module to be installed should meet the IEC 61730 CLASS Rating.

2.1 Unpacking and Inspection

	<p>Note!</p> <ul style="list-style-type: none">• Check all safety signs, warning labels and nameplates on the product.• Safety markings, warning labels and nameplates must be clearly visible and not be removed or covered before the product is scrapped.• Upon receipt of the product, check the appearance of the product and components for damage, check whether the product received is consistent with the actual product ordered, if there is a problem with the above check items, please do not install and contact Fox ESS.
---	---

2.2 Package Safety

	<p>Danger!</p> <ul style="list-style-type: none">• Make sure the product is free of any electrical connections before installation.• When installing, if drilling is required, make sure you have avoided the pipeline and electric wire in the wall.
---	---

	<p>Warning!</p> <ul style="list-style-type: none"> • Before installation, check the unit to ensure it is free of any transport or handling damage, which could affect insulation integrity or safety clearances. Choose the installation location carefully and adhere to specified cooling requirements. Unauthorized removal of necessary protections, improper use, incorrect installation, and operation may lead to serious safety and shock hazards or equipment damage. • Any time the inverter has been disconnected from the public network, please be extremely cautious as some components can retain charge sufficient to create a shock hazard. Prior to touching any part of the inverter please ensure surfaces and equipment are under touch with safe temperatures and voltage potentials before proceeding.
	<p>Caution!</p> <ul style="list-style-type: none"> • If the product supports lifting and handling methods and needs to be lifted by heavy tools, it is prohibited for people to pass or stay underneath the product. • When handling the product, please consider the weight of the product and take care to maintain balance to prevent the product from tipping or falling.
	<p>Note!</p> <ul style="list-style-type: none"> • Before handling the product, always check to make sure that the tools you are using have been regularly maintained. • Before connecting the inverter to the power distribution grid, contact the local power distribution grid company to get appropriate approvals. This connection must be made only by qualified technical personnel. • Do not install the equipment in adverse environmental conditions such as in close proximity to flammable or explosive substances; in a corrosive environment; where there is exposure to extremely high or low temperatures; or where humidity is high. • Do not use the equipment when the safety devices do not work or are disabled. • Inform the manufacturer about non-standard installation conditions. • Use personal protective equipment, including gloves and eye protection during the installation.

2.3 Electrical Connection Safety

	<p>Danger!</p> <ul style="list-style-type: none"> • Before making electrical connections, make sure that the inverter is not damaged, otherwise it may be dangerous! • Always make sure that the inverter and all switches connected to it are disconnected before electrical connections are made, otherwise there is a risk of electric shock. • When making electrical connections, be sure to wear personal protective equipment and use special insulating tools. • Before touching a DC cable, always use a measuring device to
---	--

	<p>ensure that the cable is not energized.</p> <ul style="list-style-type: none"> • The inverter must not be connected to a PV string that requires positive or negative grounding.
	<p>Warning!</p> <ul style="list-style-type: none"> • Before supplying power, connect the ground wire. • Incorrect grounding can cause personal injury, death or equipment failure and increase electromagnetic interference. • Ensure that the size of the grounding wire meets the requirements of the safety regulations. • The cables used in the PV power system must be of suitable size, firmly connected and well insulated. • Before connecting the DC connector to the inverter, please check the positive and negative polarity of the PV string and insert the DC connector into the corresponding DC terminal. • During the installation and operation of the inverter, please make sure that the positive or negative pole of the PV string will not be shorted to ground. Otherwise, it may cause AC and DC short circuit of the inverter, resulting in product damage, and loss caused is not covered by the warranty.

2.4 Operation Safety

When routing cables, ensure a distance of at least 30 mm between the cables and heat-generating components or areas to protect the insulation layer of cables from aging and damage.

	<p>Danger!</p> <ul style="list-style-type: none"> • Do not touch the product enclosure. • It is strictly forbidden to plug and unplug any connector on the inverter. • Do not touch any wiring terminal of the inverter. Otherwise, electric shock may occur. • Do not disassemble any parts of the inverter. Otherwise, electric shock may occur. • It is strictly forbidden to touch any hot parts of the inverter (such as the heat sink). Otherwise, it may cause burns. • Do not connect or remove any PV string or any PV module in a string. Otherwise, electric shock may occur. • If the inverter is equipped with a DC switch, do not operate it. Otherwise, it may cause device damage or personal injury.
---	---

2.5 Maintenance Safety

Risk of inverter damage or personal injury due to incorrect service!

	<p>Danger!</p> <ul style="list-style-type: none"> • Before maintenance, disconnect the AC circuit breaker on the grid side and then the DC switch. If a fault that may cause personal injury or device damage is found before maintenance, disconnect the AC
---	--

	<p>circuit breaker and wait until the night before operating the DC switch. Otherwise, a fire inside the product or an explosion may occur, causing personal injuries.</p> <ul style="list-style-type: none"> • After the inverter is powered off for 15 minutes, measure the voltage and current with professional instrument. Only when there is no voltage nor current can operators who wear protective equipment operate and maintain the inverter. • Even if the inverter is shut down, it may still be hot and cause burns. Wear protective gloves before operating the inverter after it cools down. • The power grid side may generate voltage. Always use a standard voltmeter to ensure that there is no voltage before touching.
	<p>Note!</p> <ul style="list-style-type: none"> • Do not use the equipment if any operating anomalies are found. Avoid temporary repairs. • All repairs should be carried out using only approved spare parts, which must be installed in accordance with their intended use and by a licensed contractor or authorized Fox ESS service representative. • If the paint on the inverter enclosure falls or rusts, repair it in time. Otherwise, the inverter performance may be affected. • Do not use cleaning agents to clean the inverter. Otherwise, the inverter may be damaged, and the loss caused is not covered by the warranty. • As the inverter contains no parts that can be maintained, never open the enclosure of the inverter or replace any internal components without authorization. Otherwise, the loss caused is not covered by the warranty. • To avoid the risk of electric shock, do not perform any other maintenance operations beyond those described in this manual. If necessary, contact Fox ESS. Otherwise loss caused is not covered by the warranty.

2.6 Disposal Safety

Please scrap the product in accordance with relevant local regulations and standards to avoid property losses or casualties.

3. Introduction

3.1 Product Introduction

V30, V33, V36, V40, V50, V60, V75, VL15, VL20, VL25, VL30, VL37.5 are three-phase non-isolated grid-tied inverters, which are important components of PV power generation systems. The inverter converts the direct current generated by the photovoltaic cells into alternating current that meets the requirements of the grid and feeds into the grid.

	<p>Warning! Do not connect any local load between the inverter and the AC circuit breaker.</p>
---	---

The intended usage of the inverter is illustrated in the following figure:

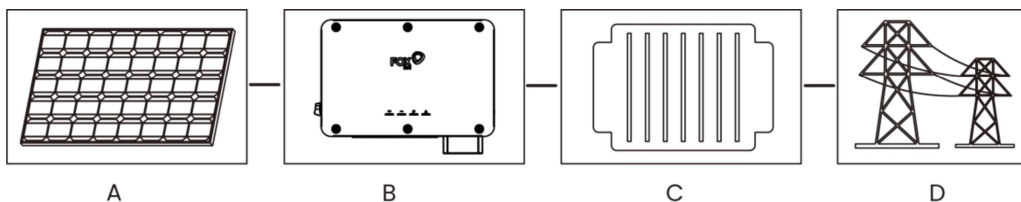

No.	Name	Description
A	PV strings	Monocrystalline silicon, polycrystalline silicon and thin-film without grounding.
B	Inverter	V Series & VL Series
C	Transformer	Boost the output voltage from the inverter to a level that meets the requirements of the grid. (Optional)
D	Utility grid	The following figure shows the common grid configurations.

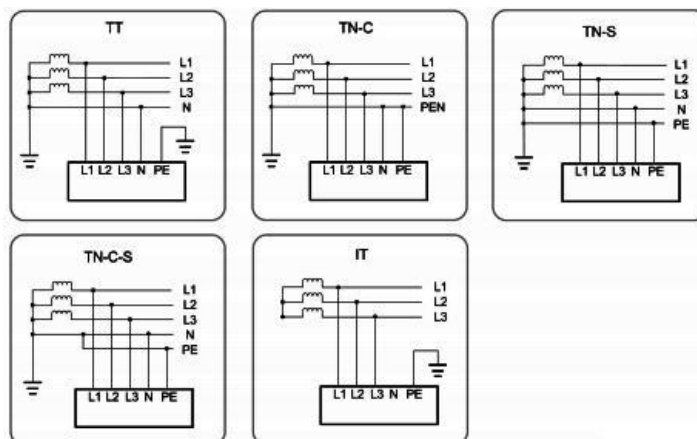

	<p>Note! In a TT power grid, the N-PE voltage should be lower than 30V.</p>
---	--

3.2 Basic Features

The three-phase high-performance inverters cover 15kW to 75kW. V30 and V33 are integrated with 3 MPP trackers. VL15, VL20, VL25, VL30, VL37.5, V36, V40 and V50 are integrated with 4 MPP trackers. V60 and V75 are integrated with 6 MPP trackers. The conversion efficiency is high, and the product is stable and reliable.

System advantages:

- LED status indications
- Integrated with PID recovery function
- Optimized MPP tracking technology
- 3/4/6 MPP trackers
- Side wiring without opening the cover
- Wide MPPT input range
- Remote monitoring via PC or Mobile App
- Supports I/V scanning, intelligent diagnosis, night SVG, AFCI detection and fault recording
- Max. Efficiency up to 98.7%, EU efficiency up to 98.4%, THD<3%
- Supports protection functions such as anti-islanding protection, DC reverse connection protection, AC short-circuit protection, leakage current protection, and surge protection
- IP66 protection level

3.3 Size

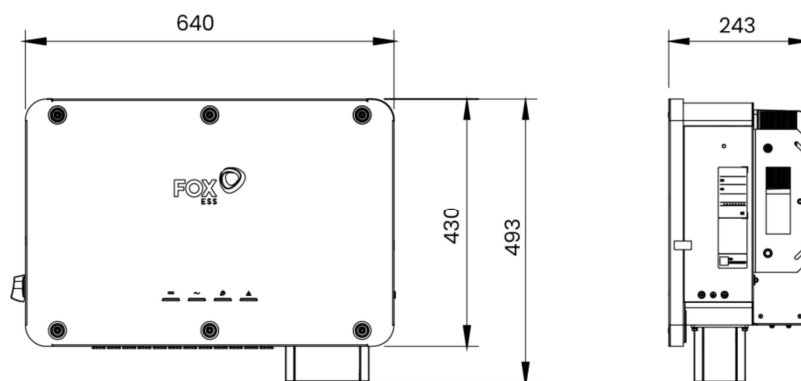

*This manual uses the V75 model as illustration example.

3.4 LED Indicator Panel

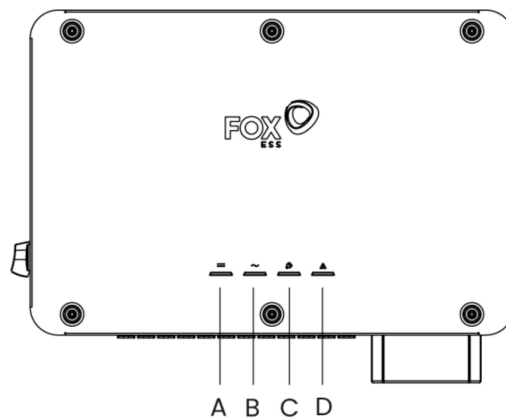

No.	Indicator	Status	Description
A	PV connection indicator (Light blue)	Steady On	At least one PV string is properly connected, and the DC input voltage of the corresponding MPPT circuit is at least 200 V. The solar inverter is in grid-tied mode.
		Blinking (1s on and 1s off)	At least one PV string is properly connected, and the DC input voltage of the corresponding MPPT circuit is at least 200 V. The solar inverter is not in grid-tied mode.
		Off	The solar inverter disconnects from all PV strings, or the DC input voltage of all MPPT circuits is less than 200V. The solar inverter is not in grid-tied mode.
B	Grid indicator (Light blue)	Steady On	Grid voltage is in normal range. The solar inverter is in grid-tied mode.
		Blinking (1s on and 1s off)	Grid voltage is in normal range. The solar inverter is not in grid-tied mode.
		Off	Grid voltage is not in normal range. The solar inverter is not in grid-tied mode.
C	PID Recovery indicator (Light blue)	Steady On	PID recovery is on.
		Blinking (1s on and 1s off)	An alarm of PID recovery is generated.
		Off	PID recovery is off.
D	Alarm indicator (Red)	Steady On	An alarm is generated.
		Off	No alarm.

3.5 Terminals of Inverter

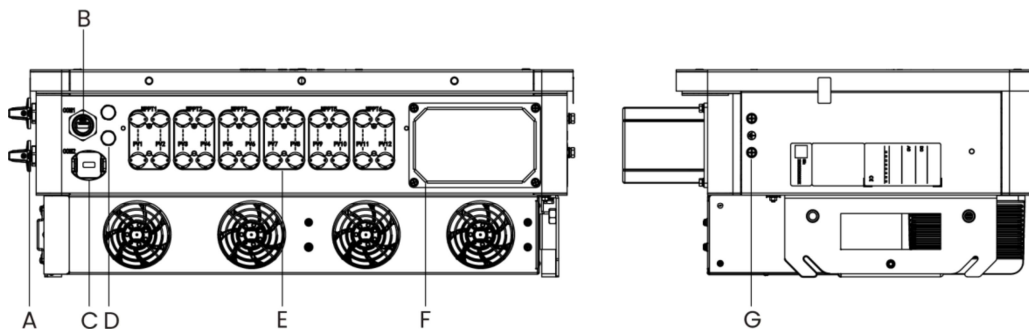

Item	Name	Description
A	DC Switch	It is used for controlling DC input.
B	Communication Terminal	It matches with the monitoring module.
C	Communication Terminal	It is used for RS485 communication and DI/DO wiring.
D	Waterproof Vent Valve	It is undetachable and usable for making the case waterproof and air-permeable.
E	DC Input Terminal	V30 and V33 have 6 pairs of PV connectors; VL15, VL20, VL25, VL30, VL37.5, V36, V40 and V50 have 8 pairs of PV connectors; V60 and V75 have 12 pairs of PV connectors;
F	AC Output Terminal	It is used for AC grid connection wiring.
G	Secondary Ground Terminal	There are two secondary ground terminals for reliable grounding of the inverter, at least one of which is selected for grounding.

3.6 Circuit Diagram

The following figure shows the main circuit of the inverter.

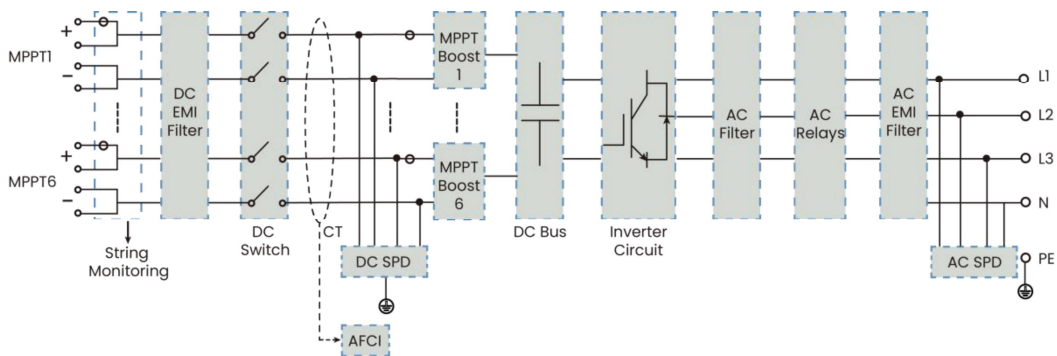

- The DC switch is used to safely cut off the DC current when necessary to ensure the safe operation of the inverter and the safety of personnel.
- EMI filters can filter out the electromagnetic interference inside the inverter to ensure that the inverter meets the requirements of electromagnetic compatibility standards.
- The MPPT is used to ensure a maximum power from PV arrays at different PV input conditions.
- The Inverter Circuit converts the DC power into grid-compliant AC power and feeds it into the grid.
- The AC filter filters the output AC component of high frequency to ensure that the output current meets the grid requirements.
- The AC relay isolates the AC output of the inverter from the grid, making the inverter safe from the grid in case of inverter failure or grid failure.

- The AC SPD provides a discharge circuit for the AC side overvoltage to prevent it from damaging the internal circuits of the inverter.

3.7 AFCI Function (Optional)

When the photovoltaic modules or cables of the inverter are poorly connected or damaged, it may generate arcs. Arcs can potentially lead to fires.

The V series and VL series inverters are equipped with AFCI detection function (Optional), which is used to detect series arc faults between the photovoltaic array and the inverter. By continuously monitoring the current signal of the circuit between the photovoltaic array and the inverter in real-time, it will rapidly shut off the circuit when an abnormal arc signal is identified owing to the AFCI function. This helps to prevent electrical safety issues caused by arcs, thereby providing assurance for the safety of users' lives and properties.

3.7.1 Function Introduction

- AFCI Monitoring: This function can be used to detect whether serial fault arc occurs in the loop between PV array and the inverter.
- AFCI Self-test: This function is intended to test whether AFCI works as normal.
- AFCI Alarm Clearing: When the inverter detects the AFCI alarm, it stops working. Clear the AFCI alarm so that the inverter can restart the detection.
- Protection Coverage: Two types of classifications are defined for AFCI protection: "F" (Full Coverage) and "P" (Partial Coverage). Full coverage protection ("F") is available for V series and VL series inverters.
- AFPE (Arc Fault Protection Equipment): The inverter is equipped with a fully integrated AFPE, which is implemented within the inverter, including arc plates and current sensors.
- Method of Implementation: Two implementation methods are available for AFCI protection, "D" and "I". "D" represents "Distributed detection system", where the AFPE comprises more than one device. The devices may be standalone devices or partially integrated within the power conversion equipment (PCE). "I" represents "PCE integrated device", where the AFPE is implemented within a PCE connected to the PV array. V series and VL series inverters adopt "I"

3.7.2 Alarm Clear

The inverter is equipped with AFCI alarm automatic clearing mechanism. If the alarm is triggered < 5 times within 24 hours, the inverter will automatically clear the alarm; if the alarm is triggered ≥ 5 times within 24 hours, the lockout protection state will be triggered. Manual alarm clearing locally is required to making the inverter back into normal operation.

Alarm clearing mechanism: Upon detection of a real arc alarm, the device will trigger an arc alarm and stop operating. For the first to fourth occurrences of arc alarms within the same day, the device will stop operating for 5 minutes and wait for the alarm to be automatically cleared before restarting. When the fifth or subsequent arc alarm occurs, the device will stop operating and will not automatically resume operation on the same day.

For the first to fourth occurrences of arc alarms, the ARM will send a command to clear the arc alarm after 5 minutes of each alarm. Then the arc alarm will be cleared and the device will restart and reconnect to the grid. When the fifth arc alarm is detected, the ARM will not clear the arc alarm, and the device will report the arc alarm and stop operating. The user needs to manually clear the alarm to restart the device and reconnect it to the grid. Alternatively, the user can wait for the alarm to be automatically

cleared the next day. For instructions on how to manually clear fault alarms, please refer to “Manual Alarm Clearing Locally” and “Manual Re-clearing Alarm Remotely”.

V series and VL series inverters has two manual alarm clearing methods:

3.7.2.1 Manual Alarm Clearing Locally

When an arc alarm occurs, user can clear alarm manually. User can access the Web Server (192.168.7.1) by connecting to the monitoring module WiFi. Select “Advanced (String & PE Monitoring)” → “AFCI Alarm Clearing” → “Enable” → “Edit”. Then wait for the alarm to be cleared, and restart the inverter.

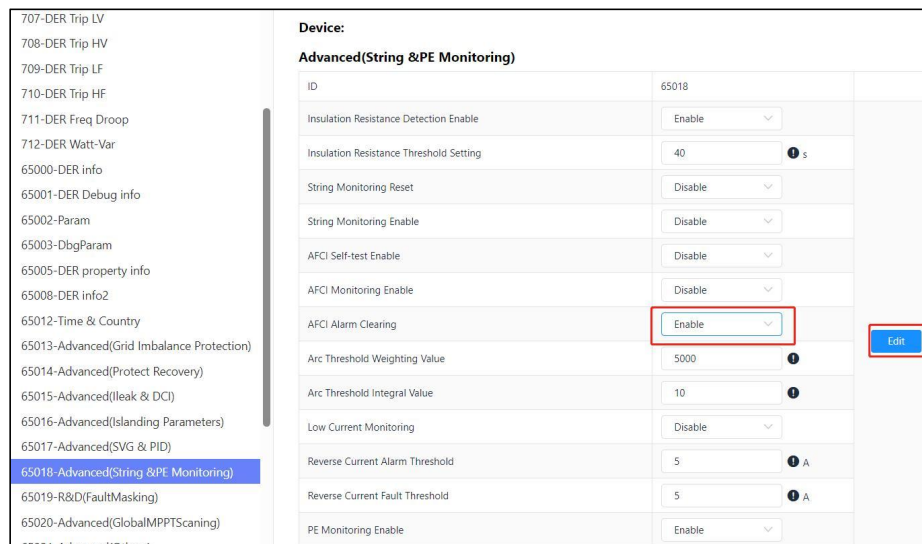

3.7.2.2 Manual Re-clearing Alarm Remotely

When an arc alarm occurs, user can clear alarm by remote access to AFPE. User can log in FoxCloud remotely, then locate the corresponding inverter of the target power station. Click “Remote Setting”. Choose “Advanced (String & PE Monitoring)” → “AFCI Alarm Clearing” → “Enable” → “OK”. Then wait for the alarm to be cleared, and restart the inverter.

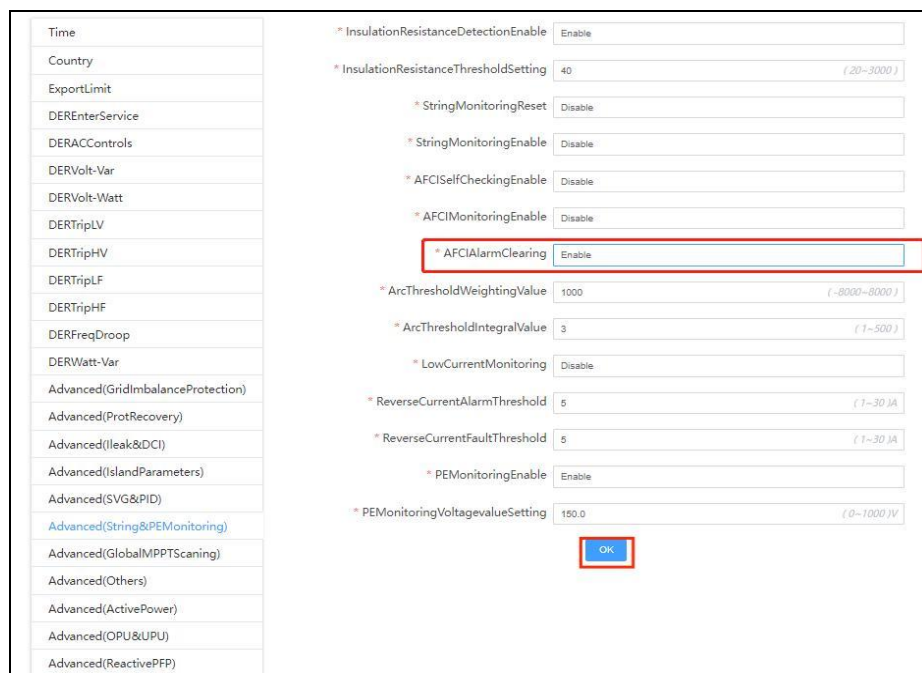

3.7.3 AFCI Protection Configuration

V series and VL series Inverters AFCI configuration is as shown in the following table.

Model	VL15, VL20, VL25, VL30, VL37.5, V36, V40, V50	V30, V33	V60, V75
Classification	F-I-AFPE-2-4-1	F-I-AFPE-2-3-1	F-I-AFPE-2-6-1
Number of Input Ports per Channel	4	3	6
Rated Channel Current	160 A	120 A	240 A
Maximum Current per Input Port	20		
Rated Interruption Current	20 A		
Number of Monitored Channels	1		
Number of Monitored Strings per Input Port	2		

4. Technical Parameters

4.1 DC Input/AC Output for V Series

Model	V30	V33	V36	V40
Input(DC)				
Max. Input Voltage	1100 V	1100 V	1100 V	1100 V
Start-up Input Voltage	185 V	185 V	185 V	185 V
Rated Input Voltage	600 V	600 V	600 V	600 V
MPPT Operating Voltage Range	160 V-1000 V	160 V-1000 V	160 V-1000 V	160 V-1000 V
MPPT Operating Voltage Range (Full Load)	550 V-800 V	550 V-800 V	550 V-800 V	550 V-800 V
No. of Independent MPPT/No. of PV Strings per MPPT	3/2	3/2	4/2	4/2
Max. Input Current of Each MPPT	40 A	40 A	40 A	40 A
Max. Short-circuit Current of Each MPPT	50 A	50 A	50 A	50 A
Max. Inverter Backfeed Current to the Array	0 A	0 A	0 A	0 A
Output(AC)				
Nominal Output Power	30 kW	33 kW	36 kW	40 kW
Nominal Output Apparent Power	30 kVA	33 kVA	36 kVA	40 kVA
Max. AC Active Power	33 kW	36.3 kW	39.6 kW	44 kW
Max. AC Apparent Power	33 kVA	36.3 kVA	39.6 kVA	44 kVA
Max. Output Current	50.2 A	55.2 A	60.2 A	66.9 A
Nominal Output Voltage	380 V/400 V, 3W+N+PE			
Nominal AC Grid Frequency	50 Hz/60 Hz			
Adjustable Power Factor	0.8 leading-0.8 lagging			
THDi	<3%			
Current (Inrush)	77.5 A, 3.2 ms			
Maximum Output Fault Current	507 A, 35 us			
Maximum Output Overcurrent Protection	235 A			

Model	V50	V60	V75
Input(DC)			
Max. Input Voltage	1100 V	1100 V	1100 V
Start-up Input Voltage	185 V	185 V	185 V
Rated Input Voltage	600 V	600 V	600 V
MPPT Operating Voltage Range	160 V-1000 V	160 V-1000 V	160 V-1000 V
MPPT Operating Voltage Range (Full Load)	550 V-800 V	550 V-800 V	550 V-800 V
No. of Independent MPPT/No. of PV Strings per MPPT	4/2	6/2	6/2
Max. Input Current of Each MPPT	40 A	40 A	40 A
Max. Short-circuit Current of Each MPPT	50 A	50 A	50 A
Max. Inverter Backfeed Current to the Array	0 A	0 A	0 A
Output(AC)			
Nominal Output Power	50 kW	60 kW	75 kW
Nominal Output Apparent Power	50 kVA	60 kVA	75 kVA
Max. AC Active Power	55 kW	66 kW	75 kW
Max. AC Apparent Power	55 kVA	66 kVA	75 kVA
Max. Output Current	83.6 A	100.3 A	114 A
Nominal Output Voltage	380 V/400 V, 3W+N+PE		
Nominal AC Grid Frequency	50 Hz/60 Hz		
Adjustable Power Factor	0.8 leading-0.8 lagging		
THDi	<3%		
Current (Inrush)	77.5 A, 3.2 ms		
Maximum Output Fault Current	507 A, 35 us		
Maximum Output Overcurrent Protection	235 A		

4.2 DC Input/AC Output for VL Series

Model	VL15	VL20	VL25	VL30	VL37.5
Input(DC)					
Max. Input Voltage	1100 V	1100 V	1100 V	1100 V	1100 V
Start-up Input Voltage	250 V	250 V	250 V	250 V	250 V
Rated Input Voltage	360 V	360 V	360 V	360 V	360 V
MPPT Operating Voltage Range	200 V -1000 V	200 V -1000 V	200 V -1000 V	200 V -1000 V	200 V -1000 V
MPPT Operating Voltage Range (Full Load)	320 V- 800 V	320 V -800 V	320 V -800 V	320 V -800 V	320 V -800 V
No. of Independent MPPT /No. Of PV Strings per MPPT	4/2	4/2	4/2	4/2	4/2
Max. Input Current of Each MPPT	40 A	40 A	40 A	40 A	40 A
Max. Short-circuit Current of Each MPPT	50 A	50 A	50 A	50 A	50 A
Max. Inverter Backfeed Current to the Array	0 A	0 A	0 A	0 A	0 A
Output(AC)					
Nominal Output Power	15 kW	20 kW	25 kW	30 kW	37.5 kW
Nominal Output Apparent Power	15 kVA	20 kVA	25 kVA	30 kVA	37.5 kVA
Max. AC Active Power	16.5 kW	22 kW	27.5 kW	33 kW	37.5 kW
Max. AC Apparent Power	16.5 kVA	22 kVA	27.5 kVA	33 kVA	37.5 kVA
Max. Output Current	43.4 A	57.8 A	72.2 A	86.7 A	98.5 A
Nominal Output Voltage	220 V, 3W+N+PE				
Nominal AC Grid Frequency	50 Hz/60 Hz				
Adjustable Power Factor	0.8 leading-0.8 lagging				
THDi	< 3%				
Current (Inrush)	77.5 A, 3.2 ms				
Maximum Output Fault Current	507 A, 35 us				
Maximum Output Overcurrent Protection	235 A				

4.3 Efficiency, Protection, and Safety





Model	VL15, VL20, VL25, VL30, VL37.5	V30, V33, V36, V40	V50, V60, V75
Efficiency			
Max. Efficiency	98.1%	98.7%	98.5%
Euro. Efficiency	97.6%	98.4%	98.1%
Protection			
DC Switch	Yes		
DC Reverse Polarity Protection	Yes		
AC Short-circuit Protection	Yes		
AC Overcurrent Protection	Yes		
Insulation Monitoring	Yes		
Residual Current Monitoring	Yes		
PV String Current Monitoring	Yes		
PID Recovery	Yes		
Grid Monitoring	Yes		
Night SVG	Yes		
AFCI	Optional		
DC Surge Protection	Class II		
AC Surge Protection	Class II		
DC Overvoltage Category	Class II		
AC Overvoltage Category	Class III		
Anti-Corrosion	C5		
Standard			
Safety, EMC, and Certification	IEC 62109, IEC 61727, IEC 62116, IEC 60068, IEC 61683, IEC 61000-6-3, EN 50549		

4.4 General Data

Model	VL15, VL20, VL25, VL30, VL37.5, V50, V60, V75	V30, V33	V36, V40
General Data			
Dimensions (W×H×D)	640 mm × 430 mm × 243 mm		
Weight	50 kg	41 kg	42 kg
Operating Ambient Temperature Range	-30°C to +60°C		
Cooling Method	Smart air cooling/FAN		
Operating Altitude	4000 m		
Relative Humidity Range	0~100%		
Ingress Protection Rating	IP66		
Topology	Non-isolated		
Display	LED, Wi-Fi+APP		
Communication	RS485/USB/Wi-Fi+LAN/4G		
Pollution Degree	PD2 (Inside), PD3 (Outside)		
Protective Class	Class I		
Arc Flash Detection and Protection			
Standard	IEC63027		
Protection Coverage	Full Coverage		
Method of Implementation	Integrated		
Functionality	AFPE		
Monitored String per Input Port	2		
Input Port per Monitored Channel	6/4/3		
Monitored Channels	1		

5. Installation

5.1 Installation Safety

	<p>Danger! Make sure there is no electrical connection before installation.</p>
	<p>Warning!</p> <ul style="list-style-type: none">• Please install the product in a well-ventilated environment.• Ensure that the heat dissipation system or vent is not blocked.• Do not install the product in a flammable or explosive or fuming environment.
	<p>Caution!</p> <ul style="list-style-type: none">• When handling the product, please pay attention to the weight of the product and maintain balance to prevent the product from tipping or falling.• The bottom terminals and interfaces of the inverter cannot directly contact the ground or other supports. The inverter cannot be directly placed on the ground.
	<p>Note!</p> <ul style="list-style-type: none">• Use personal protective equipment, including gloves and goggles, during installation.• Protect the product from shavings and dust.• Make sure to avoid the water and electricity wiring in the wall before drilling.

5.2 Check for Physical Damage

Make sure the inverter has not been damaged during transportation. If there is any visible damage, such as cracks, please contact your dealer immediately.

5.3 Packing List

Open the package and take out the product, please check the accessories first. The packing list is as shown as below:

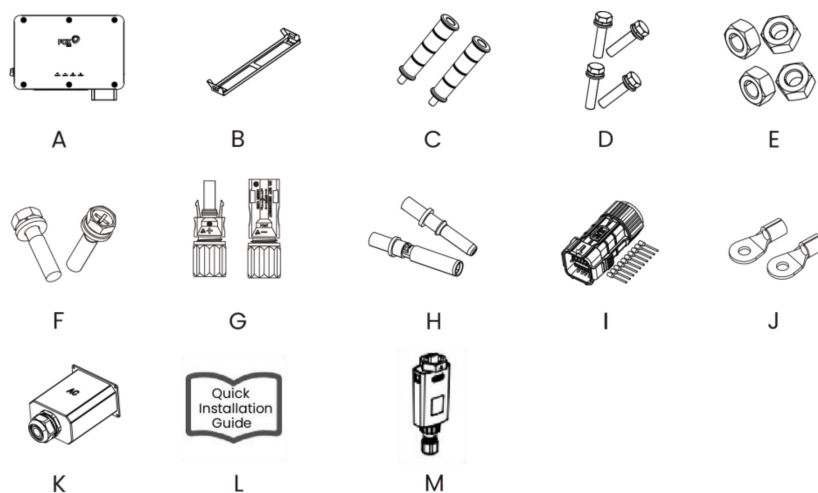

Object	Quantity	Description	Object	Quantity	Description
A	1	Inverter	H	6/8/12	DC Connector (Positive×6/8/12, Negative×6/8/12)
B	1	Hanging Plate	I	1	Communication Connector×1 (Terminal×10)
C	2	Screw-in Type Handle	J	2	Ground Terminal
D	4	M10*45 Bolt Assembly	K	1	AC Wiring Protective Cover
E	4	M10 Hexagon Nut	L	1	Quick Installation Guide
F	2	M6×25 Bolt Assembly	M	1	Monitoring Module (Optional)
G	6/8/12	DC Pin Plug (Positive×6/8/12, Negative×6/8/12)			

Note: V30 and V33 inverters are provided with DC Connector (Positive×6, Negative×6) and DC Pin Plug (Positive×6, Negative×6). VL15, VL20, VL25, VL30, VL37.5, V36, V40 and V50 inverters are provided with DC Connector (Positive×8, Negative×8) and DC Pin Plug (Positive×8, Negative×8). V60 and V75 inverters are provided with DC Connector (Positive×12, Negative×12) and DC Pin Plug (Positive×12, Negative×12).

5.4 Mounting

The inverter with protection rating IP66 can be installed both indoors and outdoors. The inverter should be installed at a height that allows easy viewing of the LED indicator panel, as well as easy electrical connection, operation and maintenance.

5.4.1 Environment Requirement

- Installation Precaution

Make sure the installation location complies with the following conditions:

- Not in direct sunlight.
- Not in areas where highly flammable materials are stored.
- Not in potential explosive areas.
- The location should not be accessible to children.
- Not in the cool air directly.
- Not near the television antenna or antenna cable.
- Not higher than altitude of about 4000m above sea level.
- Not in environment of precipitation or humidity (>100%).
- Under good ventilation condition.
- The ambient temperature in the range of -30°C to +60°C.
- The wall hanging the inverter should meet conditions below:
 1. Solid brick/concrete, or strength equivalent mounting surface;
 2. Ensure that the installation surface is solid enough to bear four times the weight of the inverter. The inverter must be supported or strengthened if the wall's strength isn't enough (such as wooden wall, the wall covered by thick layer of decoration).
- Avoid direct sunlight, rain exposure, snow laying up during installation and operation.

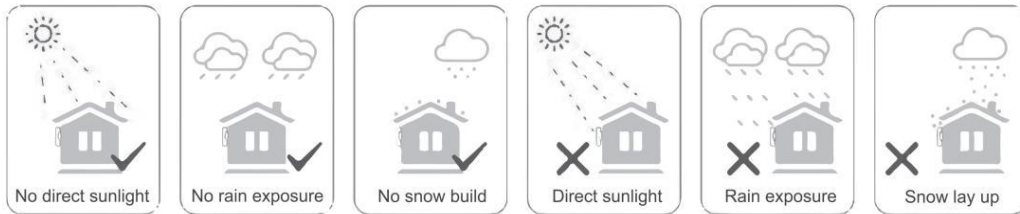

5.4.2 Space Requirement

Make sure there is enough space around the inverter for ventilation.

Space requirement for single inverter installation:

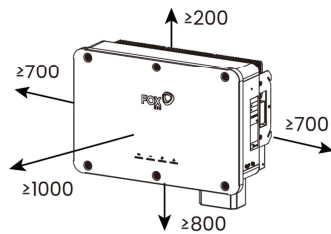

Position	Min Size
Left	700 mm
Right	700 mm
Top	200 mm
Bottom	800 mm
Front	1000 mm

Space requirement for multiple inverters installation:

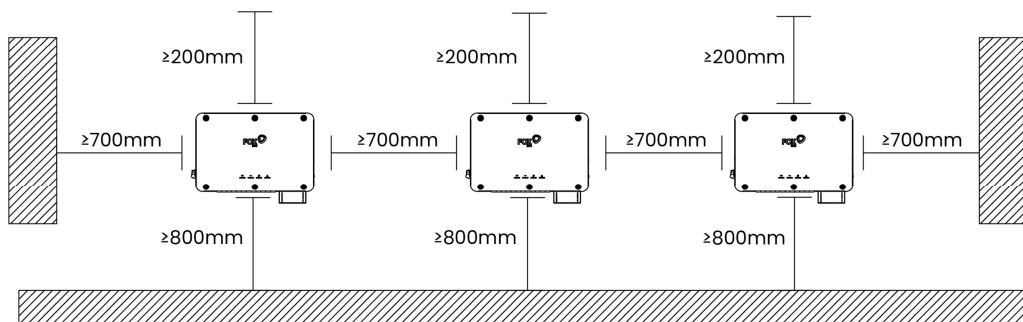

5.4.3 Angle Requirement

Install the inverter vertically or at the maximum allowable rear tilt angle. Do not install the inverter horizontally forward, excessively backward, sideways, or upside down. Inverters in floating plants cannot be installed at a back tilt.

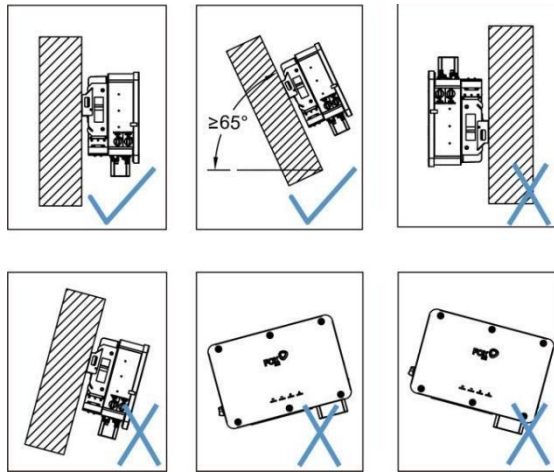

5.4.4 Installation Steps

Tools required for installation include, but not limited to, the following recommended tools. If necessary, use other auxiliary tools on the spot.

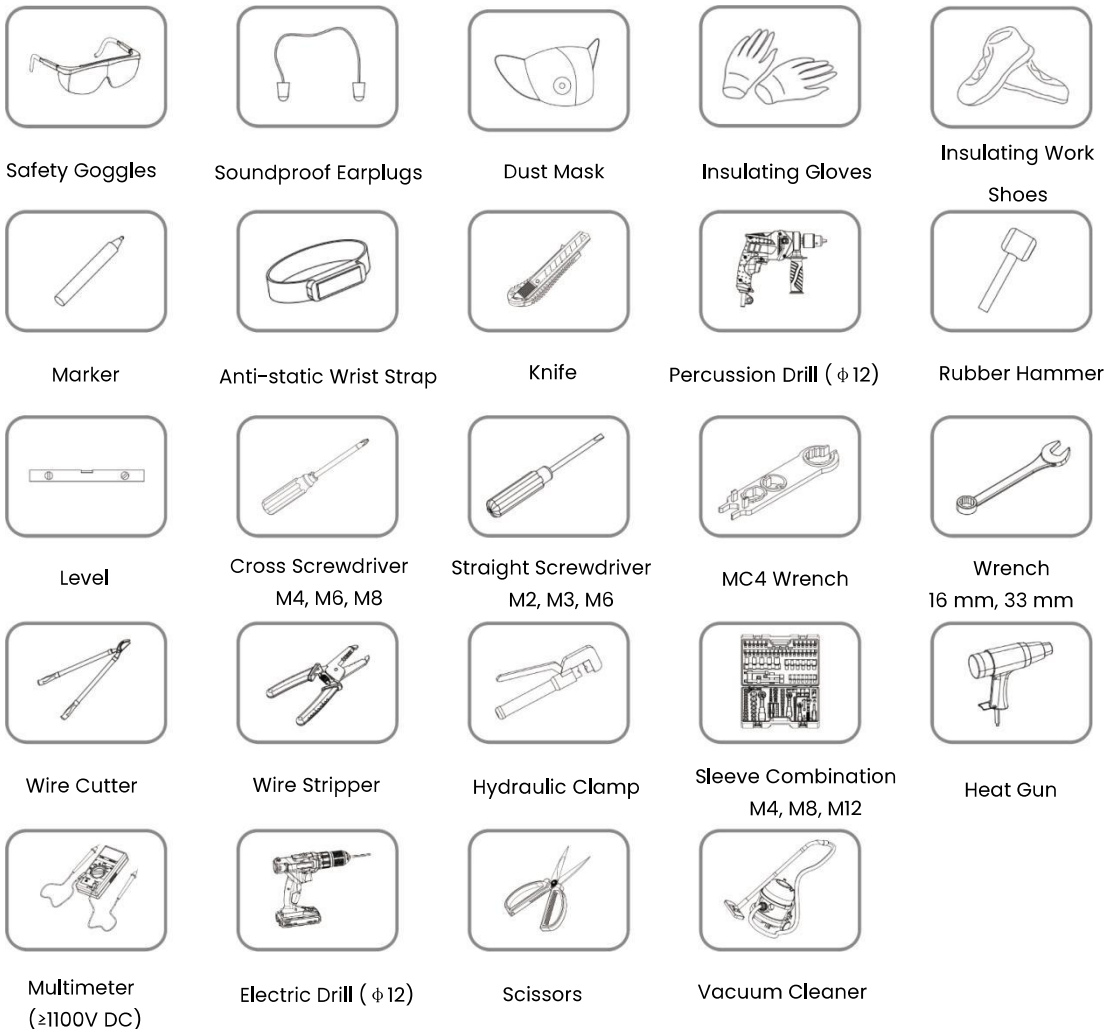

Step 1: Bracket-mounted Installation or Wall-mounted Installation

Install the Inverter on a bracket or wall by means of the hanging plate. The size of the hanging plate is shown as below:

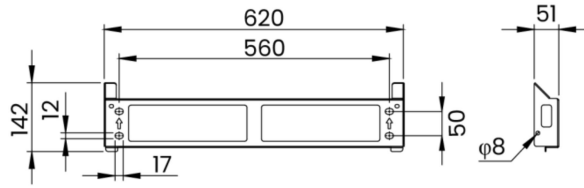

Method 1: Bracket-mounted Installation

1. Place the assembled hanging plate on PV brackets, adjust the angle with a level, mark drilling positions, and drill holes with an electric drill (with a $\phi 12$ drill bit). It is recommended to adopt two side columns way to install PV brackets.

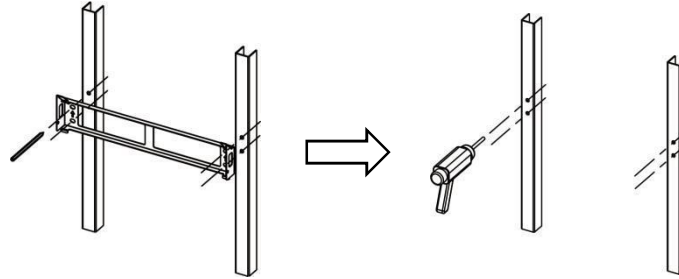

2. Fix the hanging plate with bolts.

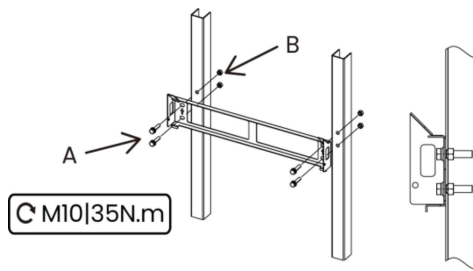

A 4 PCS of M10×45 hexagon bolts B 4 PCS of hexagon nuts

Method 2: Wall-mounted Installation

1. Place the hanging plate at the installation site, adjust the angle with a level, and mark drilling positions.

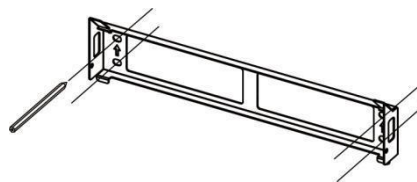

2. Drill holes with a hammer drill (with a $\phi 12$ drill bit), clear holes, insert 4 PCS of expansion bolts (by client, M10 × 95 is recommended) into holes, and fix them with a rubber hammer.

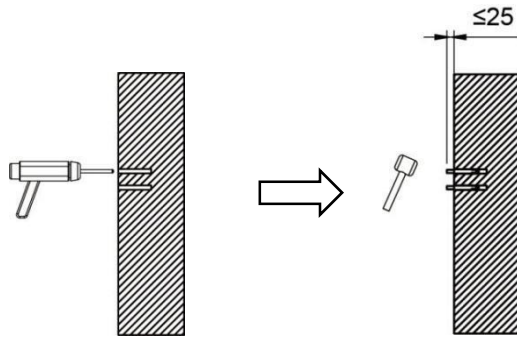

3. Fix the hanging plate with expansion bolts.

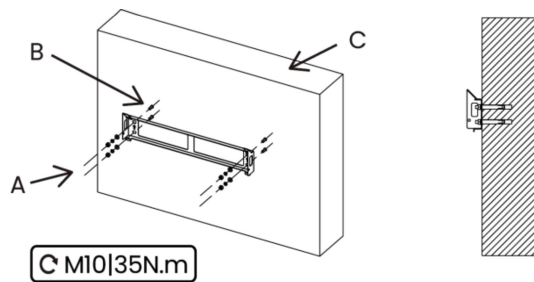

A 4 PCS of M10 hexagon nuts B 4 PCS of expansion bolts (M10) C Wall

Step 2: Inverter Installation

1. Lift the inverter from the package box with 2 PCS of screw-in type handles.

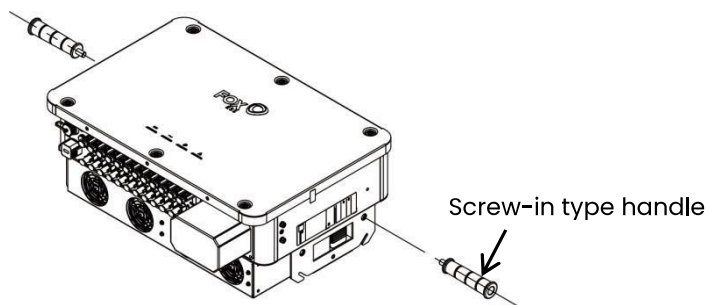

2. Install the inverter on the hanging plate, and ensure that slots of the inverter are properly matched with the hanging plate.

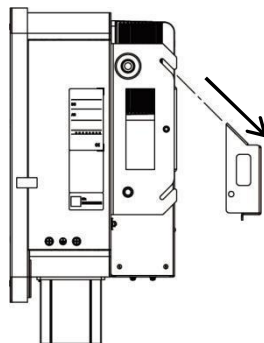

3. Secure the inverter with bolts.

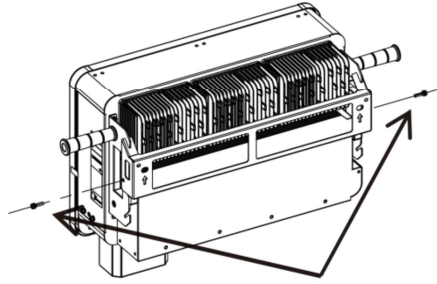



2 PCS of M6×25 bolts

C M6|4.5N.m

6. Electrical Connection

6.1 Safety Precautions

	<p>Danger!</p> <ul style="list-style-type: none"> • Must ensure that cables are voltage-free with a measuring instrument before proceeding electrical connection. • Before electrical connections, please make sure that the inverter switch and all switches connected to the inverter are set to "OFF", otherwise electric shock may occur! • Do not close the AC circuit breaker until the electrical connection is completed.
	<p>Warning!</p> <ul style="list-style-type: none"> • Install the external protective grounding cable first when performing electrical connection and remove the external protective grounding cable last when removing the inverter. Otherwise, it may cause personal injury or product damage. • Please use measuring devices with an appropriate range. Overvoltage can damage the measuring device and cause personal injury.
	<p>Note!</p> <ul style="list-style-type: none"> • Electrical connection must be performed by professionals. • Operators must wear proper personal protective equipment during electrical connections. • All cables used in the PV generation system must be firmly attached, properly insulated, and adequately dimensioned. • Cables used by the user shall comply with the requirements of local laws and regulations. • When the wiring is completed, seal the gap at the cable inlet and outlet holes with fireproof/waterproof materials such as fireproof mud to prevent foreign matter or moisture from entering and affecting the long-term normal operation of the inverter.

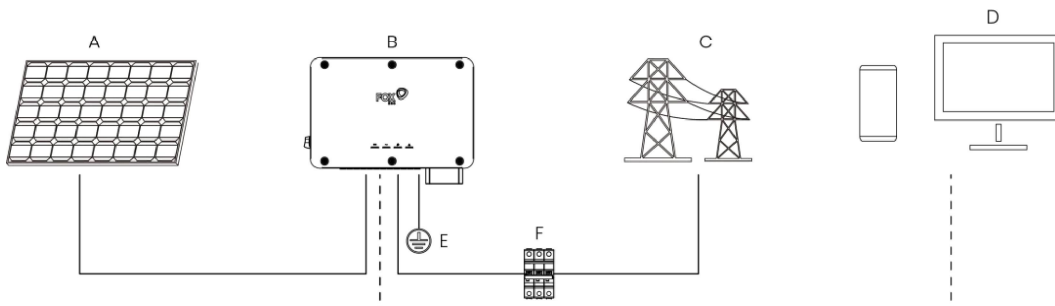

6.2 Electrical Connection Overview

Connecting the inverter to the PV system: external ground connection, grid connection and PV string connection.



Item	Name	Item	Name
A	PV Panel	D	Mobile Terminal
B	Inverter	E	Grounding
C	Grid	F	Circuit Breaker

6.3 Secondary Ground Connection

	<p>Danger!</p> <p>Make sure that the grounding cable is connected reliably. Otherwise, it may cause electric shock.</p>
	<p>Warning!</p> <ul style="list-style-type: none"> • Since the inverter topology is non-isolated, neither the negative electrode nor the positive electrode of the PV string can be grounded. Otherwise, the inverter will not operate normally. • The external protective grounding point provides a reliable ground connection. Do not use an improper grounding conductor for grounding. Otherwise, it may cause product damage or personal injury. • If the cross-sectional area of the grounding cable is not less than 10 mm² for copper wire or 16 mm² for aluminum wire, it is recommended that both the external protective grounding terminal and the AC side grounding terminal are reliably grounded. • If the cross-sectional area of the grounding cable is less than 10 mm² for copper wire or 16 mm² for aluminum wire, ensure that both the external protective grounding terminal and the AC side grounding terminal are reliably grounded.
	<p>Note!</p> <ul style="list-style-type: none"> • All non-current carrying metal parts and device enclosures in the PV power system should be grounded. • When there is only one inverter in the PV system, connect the external protective grounding cable to a nearby grounding point. • When there are multiple inverters in the PV system, connect all inverter external protective grounding terminals and the grounding points of the PV module brackets to equipotential line (according to the onsite conditions) to ensure equipotential connections.

Lock crimped ground cables to ground holes with screw locks on the inverter case, and paint the ground screws and ground terminals to improve anti-corrosion characteristics.

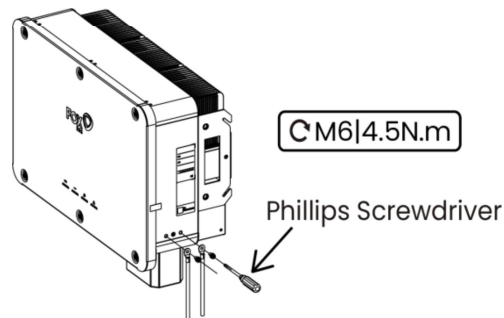

6.4 AC Wiring

6.4.1 AC Wiring Requirements



Note!

Only with the permission of the local grid department, the inverter can be connected to the grid.

AC Circuit Breaker

A separate three-pole or four-pole circuit breaker should be installed on the external AC side of each inverter to ensure safe disconnection from the grid.

Model	VL15, VL20, V30, V33, V36, V40	VL25, VL30	VL37.5, V50, V60	V75
Copper Core Cable	35–50 mm ²	35–50 mm ²	35–50 mm ²	35–50 mm ²
Aluminum Core Cable	40–50 mm ²	40–50 mm ²	40–50 mm ²	40–50 mm ²
AC Breaker	80 A	100 A	125 A	150 A

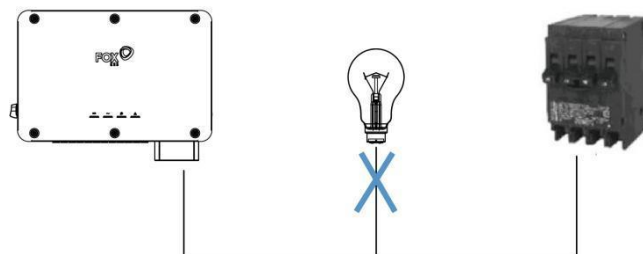

Warning!

- AC circuit breakers should be installed on the AC side of the inverter and the grid side to ensure safe disconnection from the grid.
- Multiple inverters cannot share one AC circuit breaker.

	<ul style="list-style-type: none"> Do not connect any local load between the inverter and the AC circuit breaker.
--	--

Multiple Inverters in Parallel Connection

If multiple inverters are connected in parallel to the grid, ensure that the total number of parallel inverters does not exceed 30. Otherwise please contact Fox ESS for technical solution.

6.4.2 Wiring Steps

Check the grid voltage and compare with the permitted voltage range (refer to technical data).

Disconnect the circuit-breaker of all the phases and secure against re-connection.

Preparation: Trim the cables

Cable Type	Outer Diameter (mm)	Conductor Sectional Area (mm ²)
AC Cable	18~44	L1,L2,L3,(N) cables: 35~50 (outdoor copper core cable) 40~50 (outdoor aluminum core cable) PE: S/2 (S is a sectional area of AC phase cable)

*Please refer to local cable type and color for actual installation

1. Open the AC breaker and prevent its accidental reclose. Open the AC side wiring pre-installed protective cover with a phillips screwdriver. Properly place the removed 4PCS screws for subsequent wiring reuse.

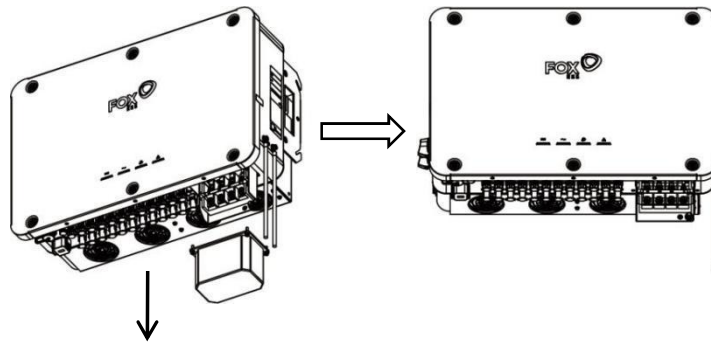

2. Unscrew the lock nut of the waterproof connector and take out multilayer sealing rings. Select the sealing ring based on the cable outer diameter. Route the cable through the lock nut and sealing ring.

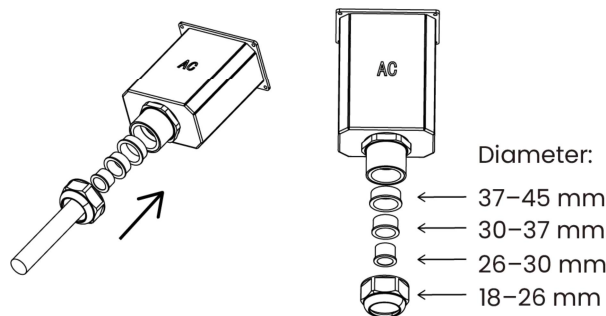

3. Crimp the cold-pressed terminals. To ensure insulation between the terminals, please sleeve the crimped section of the cold-pressed terminals with heat shrink tubing and heat it for tight fitting to prevent the tubing from loosening.

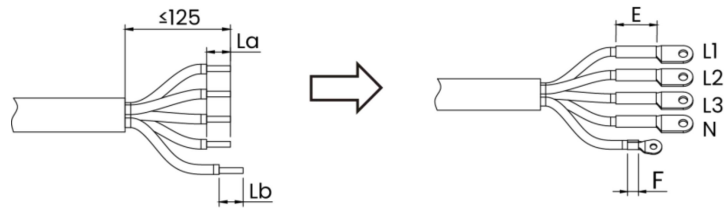

$L_a = E + 2 \sim 3$, E: Inner Diameter Depth of DT Terminal Crimping Slot;
 $L_b = F + 2 \sim 3$, F: Inner Diameter Depth of OT Terminal Crimping Slot;
 Dimension of the cold-pressed terminals:

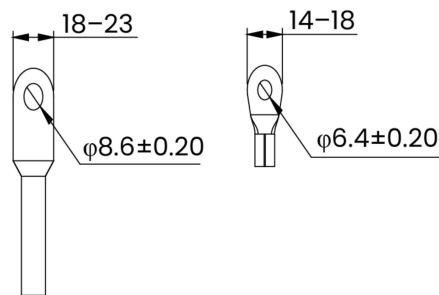

4. Secure cables to the corresponding terminals with a hexagon socket wrench and a cross screwdriver, and tighten the waterproof cable heads and close the box.

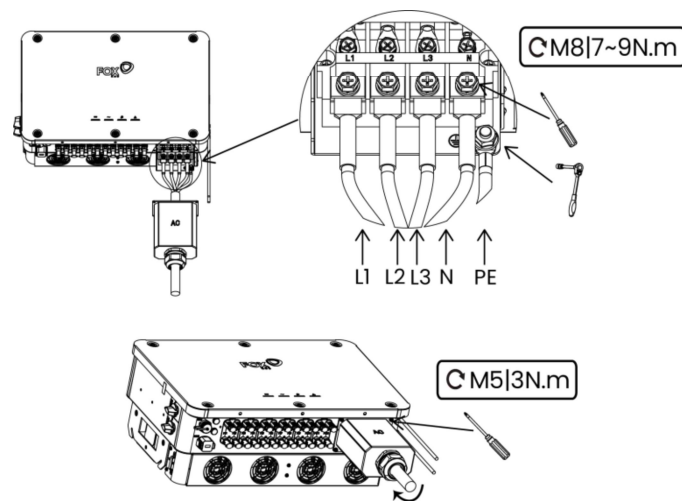

Note!

Note the positions of PE wire and N wire. If a phase wire is connected to the PE terminal or N terminal, unrecoverable damage may be caused to the inverter.

6.4.3 Aluminum Cable Requirements

If an Aluminum cable is selected, use a copper to Aluminum adapter terminal to avoid direct contact between the copper bar and the Aluminum cable.

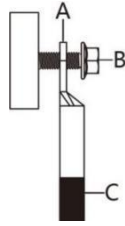

A Copper to Aluminum Adapter Terminal	B Flange Nut	C Aluminum Cable
---------------------------------------	--------------	------------------

6.5 DC Connection

This series inverters can be connected with at most 12 strings of PV modules depending on the inverter type. Please select suitable PV modules with high reliability and quality. Open circuit voltage of the module array connected should be less than 1100V, and operating voltage should be within the MPPT voltage range.

	<p>Warning!</p> <ul style="list-style-type: none"> • Make sure the PV array is well insulated to ground before connecting it to the inverter. • Do not ground the positive or negative terminal of the PV cable. • The photovoltaic modules have high voltage. Please observe electrical safety rules when proceeding electrical connection. • Before connecting the DC connector to the inverter, please check the positive and negative polarity of the PV string and make sure it is correct before inserting the DC connector into the corresponding DC terminal. • During the installation and operation of the inverter, please ensure that the positive or negative electrodes of PV strings do not short-circuit to the ground. Otherwise, an AC or DC short-circuit may occur, resulting in equipment damage. The damage caused by this is not covered by the warranty. • Electric arc or contactor over-temperature may occur if the DC connectors are not firmly in place, and the loss caused is not covered by the warranty. • If the DC input cables are reversely connected or the positive and negative terminals of different MPPT are shorted to ground at the same time, while the DC switch is in the "ON" position, do not operate immediately. Otherwise, the inverter may be damaged. Please turn the DC switch to "OFF" and remove the DC connector to adjust the polarity of the strings when the string current is lower than 0.5 A. • Inverters do not support full parallel connection of strings (Full parallel connection refers to a connection method in that strings are connected in parallel and then connected to the inverter separately). • Do not connect one PV string to multiple inverters. Otherwise, the inverters may be damaged.
	<p>Note!</p> <ul style="list-style-type: none"> • PV modules - please ensure they are the same type, have the same output and specifications, are aligned identically, and are tilted to



the same angle. In order to save cable and reduce DC loss, we recommend installing the inverter as near to the PV modules as possible.

- Mixed use of PV modules of different brands or models in one MPPT circuit, or PV modules of different orientation or inclination in a string may not damage inverter, but will cause system bad performance!
- The inverter enters standby state when the input voltage ranges between 1,000 V and 1,100 V. The inverter returns to running state once the voltage returns to the MPPT operating voltage range, namely, 200 V to 1,000 V.
- The axial tension on DC connectors must not exceed 80N. Avoid axial cable stress on the connector for a long time during field wiring.
- Radial stress or torque must not be generated on PV connectors. It may cause the connector waterproof failure and reduce connector reliability.
- Leave at least 50 mm of slack to avoid the external force generated by the cable bending affecting the waterproof performance.
- Refer to the specifications provided by the cable manufacturer for the minimum cable bending radius. If the required bending radius is less than 50 mm, reserve a bending radius of 50 mm. If the required bending radius is greater than 50 mm, reserve the required minimum bending radius during wiring.

6.5.1 PV Input Configuration

- As shown in the figure below, the inverter is provided with multiple PV inputs and each PV input is designed with an MPP tracker.
- Each PV input operates independently and has its own MPPT. In this way, string structures of each PV input may differ from each other, including PV module type, number of PV modules in each string, angle of tilt, and installation orientation.
- Each PV input area includes two PV inputs PV1 and PV2. For the best use of PV power, PV1 and PV2 should be the same in PV string structure, including the type, number, tilt, and orientation of the PV modules.

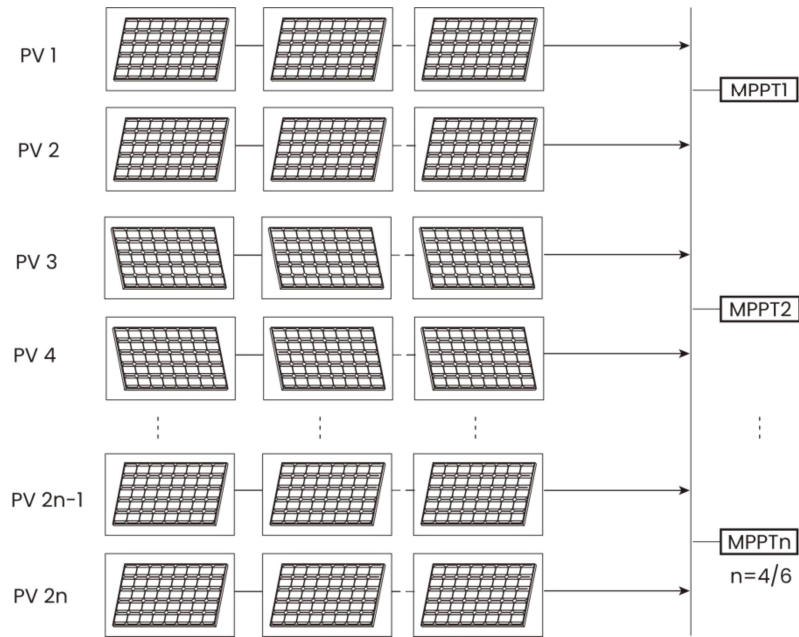

DC Input Terminals Diagram is shown as below:

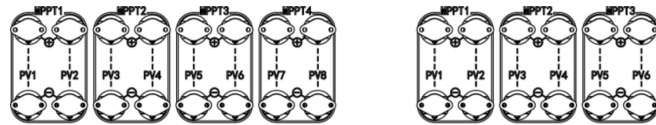

V15, V20, V25, V30, V37.5, V36, V40 and V50

V30 and V33

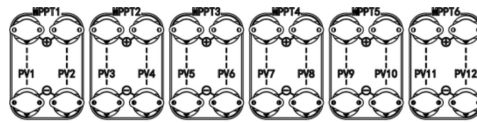

V60 and V75



Note!

The principles for selecting the DC input terminals when not all of them are used are as follows.

- The DC input lines need to be evenly distributed among 4 MPPT. For V30 and V33, priority should be given to connecting to MPPT1 and MPPT 3. For V15, V20, V25, V30, V37.5, V36, V40 and V50, priority should be given to connecting to MPPT1 and MPPT4. For the V60 and V75, priority should be given to connecting to MPPT1 and MPPT6.
- Maximize the number of MPPT connections.

V15, V20, V25, V30, V37.5, V36, V40 and V50	
Input Strings	Terminals
1	PV1
2	PV1, PV7
3	PV1, PV3, PV7
4	PV1, PV3, PV5, PV7
5	PV1, PV3, PV5, PV7, PV8

6	PV1, PV2, PV3, PV5, PV7, PV8
7	PV1, PV2, PV3, PV4, PV5, PV7, PV8
8	PV1, PV2, PV3, PV4, PV5, PV6, PV7, PV8

V30 and V33	
Input Strings	Terminals
1	PV1
2	PV1, PV3,
3	PV1, PV3, PV5,
4	PV1, PV2, PV3, PV5
5	PV1, PV2, PV3, PV4, PV5
6	PV1, PV2, PV3, PV4, PV5, PV6

V60 and V75	
Input Strings	Terminals
1	PV1
2	PV1, PV11
3	PV1, PV5, PV11
4	PV1, PV3, PV5, PV11
5	PV1, PV3, PV5, PV9, PV11
6	PV1, PV3, PV5, PV7, PV9, PV11
7	PV1, PV2, PV3, PV5, PV7, PV9, PV11
8	PV1, PV2, PV3, PV5, PV7, PV9, PV11, PV12
9	PV1, PV2, PV3, PV5, PV6, PV7, PV9, PV11, PV12
10	PV1, PV2, PV3, PV4, PV5, PV6, PV7, PV9, PV11, PV12
11	PV1, PV2, PV3, PV4, PV5, PV6, PV7, PV9, PV10, PV11, PV12
12	PV1, PV2, PV3, PV4, PV5, PV6, PV7, PV8, PV9, PV10, PV11, PV12

6.5.2 Assembling DC Connectors

1. Rotate the DC switch to "OFF" position.

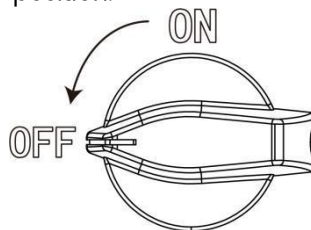

2. Check the cable connection of the PV string for polarity correctness and ensure that the open circuit voltage in any case does not exceed the inverter input limit of 1,100V.

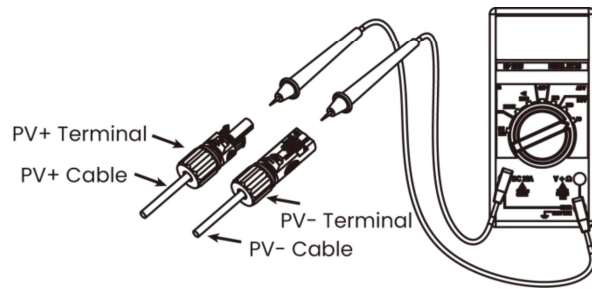

3. Connect the DC connectors to corresponding terminals.

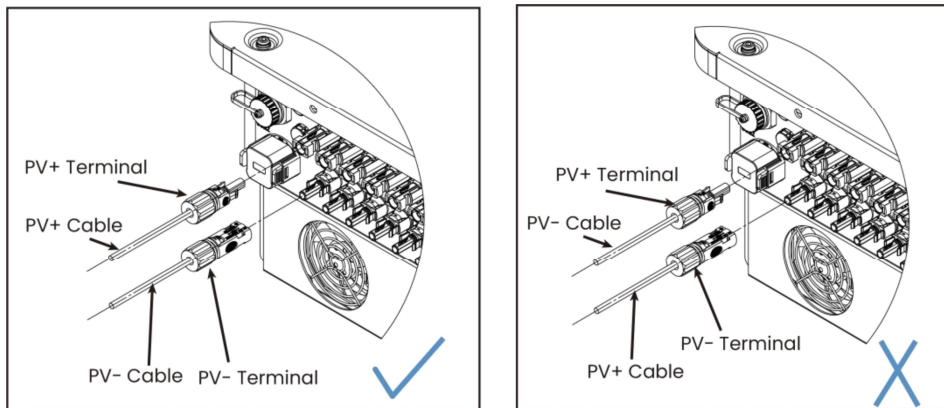

Note!

The multimeter must have a DC voltage range of at least 1100 V. If the voltage is a negative value, the DC input polarity is incorrect. Please correct the DC input polarity. If the voltage is greater than 1100 V, too many PV modules are configured to the same string. Please remove some PV modules.

4. Follow the foregoing steps to connect DC connectors of other PV strings.
5. Seal any unused DC terminal with a terminal cap.

6.5.3 DC Wiring



Note!

- Use MC4 DC terminals.
- To ensure IP66 protection, use only the supplied connector.
- It is recommended that the DC cable dedicated to photovoltaics (2.5–4 mm²) be used to connect the PV module.

1. Turn off the DC switch.
2. Trim about 6 mm of insulation from the cable end.



3. Separate the DC connector as below.

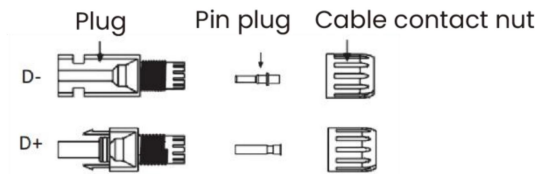

4. Insert multiple cables connected to the PV module into the pin plug and ensure all strands are captured in the pin plug. Crimp the pin plug with a crimping plier.

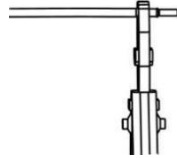

5. Route the crimped cable through the nut into the plug. When you hear a "click", the pin plug is properly clamped in the plug.

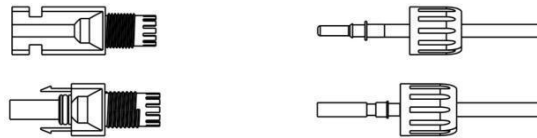

6. Unlock the DC connector.

- Use the specified wrench tool.
- When separating the DC+ connector, push the tool down from the top.
- When separating the DC- connector, push the tool up from the bottom.
- Separate the connectors by hand.

6.6 Communication Device Installation

6.6.1 Communication Connector Wiring Steps

Installation steps are as below:

1. Remove the COM communication terminal waterproof cap on the inverter.

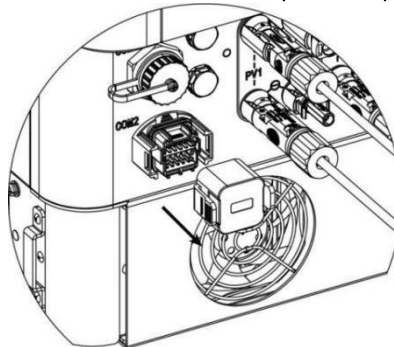

2. Crimp the communication cable or resistor wire with a tube terminal.

Single Wire Crimping

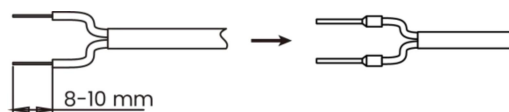



Note!

Communication Cable Specification: Shielded Twisted Pair, Single Wire
0.35–0.75 mm²

Combining with Resistor Wire and Crimping

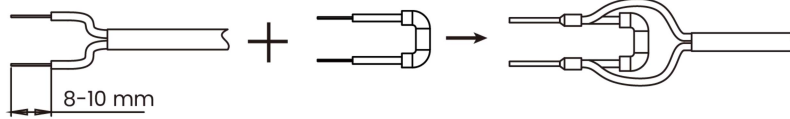

Note!

Communication cable cross-section not greater than 0.35 mm².

Single Resistor Wire Crimping

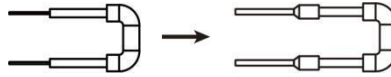

Note!

To ensure good contact between the communication connector and the communication cable, the tube terminal connecting to communication connector shall be paired with parts supplied or parts of the same size and specification.

3. Pass the communication cable with pressed tube terminal through the communication connector shell, and then plug it into the corresponding PIN port of the rubber core, and tighten the tail nut to ensure the sealing.

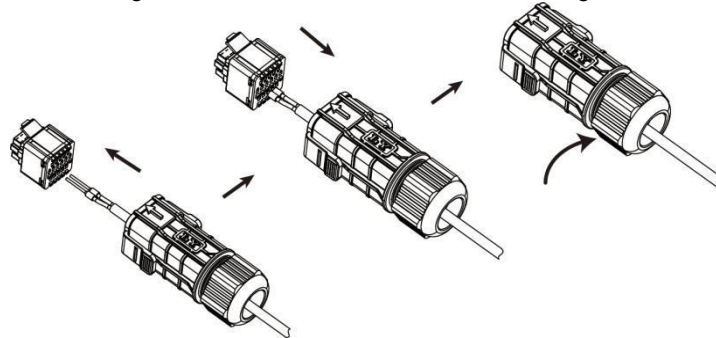

*This manual takes twisted pair cable as an example for illustration.

4. Plug the communication connector into inverter.

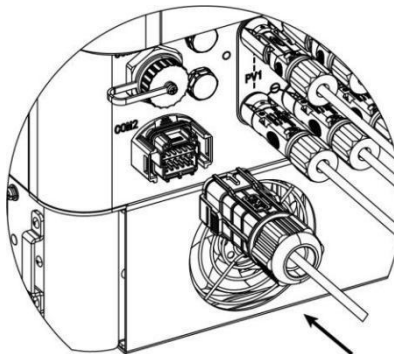

6.6.2 Wire Sequence of the Rubber Core

The wire sequence of the rubber core is shown as below:

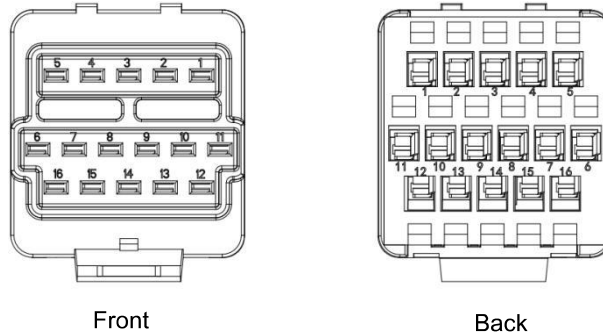

PIN	Name	Description
1	ISO_GND	Signal Earth
2	RS485A	RS485 communication port
3	RS485B	
4	Reserve485A	Reserved RS485 communication port
5	Reserve485B	
6	Meter485A	Meter communication port
7	Meter485B	
8	Reserve485A	Reserved RS485 communication port
9	Reserve485B	
10	DI1	Digital Input Port1
11	DI2	Digital Input Port2
12	DI3	Digital Input Port3
13	DI4	Digital Input Port4
14	DRM0	Demand Response Mode
15	E_STOP	Emergency Stop
16	ISO_GND	Signal Earth

6.6.3 Ripple Control (Optional)

In some regions, grid operators use Ripple Control Receivers to convert grid dispatch signals into dry contact format for transmission. Power plants could receive grid dispatch signals with the help of dry contact communication method.

The inverter can be connected to the RRCR (Radio Ripple Control Receiver) to dynamically limit the output power of all inverters in the power plant.

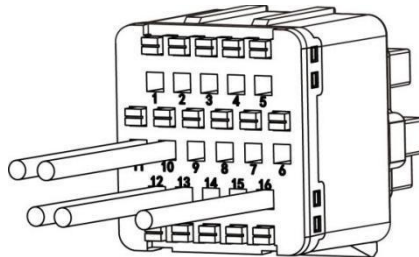



Note!

Use 1.5 mm² twin-core or multi-core cables.

Plug the ripple control cables into terminal 10 (DI1), terminal 11 (DI2), terminal 12 (DI3), terminal 13 (DI4) and terminal 16 (ISO_GND).

The inverter is configured by default with the following RRCR power levels:

DI1	DI2	DI3	DI4	Power Level	Cos(θ)
0	0	0	1	None	Null
0	0	1	0	0%	1
0	1	0	0	30%	1
1	0	0	0	60%	1
0	0	0	0	100%	1

6.6.4 Monitoring Module (Optional)

Plug the Fox ESS monitoring module into the inverter. After successful connection, information such as power generation and running state of the inverter can be viewed via the APP on the phone.

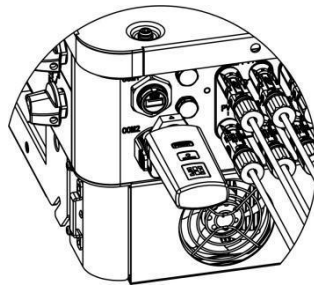

Connection Steps:

1. Plug the monitoring device into "WiFi/4G/USB" port at the bottom of the inverter.
2. Set up the site account on the Fox ESS monitoring platform (please refer to the monitoring user manual for more details).

*For monitoring module: There is SIM card in the device.

6.6.5 Communication Connector Application Method

6.6.5.1 Single Inverter Communication Wiring

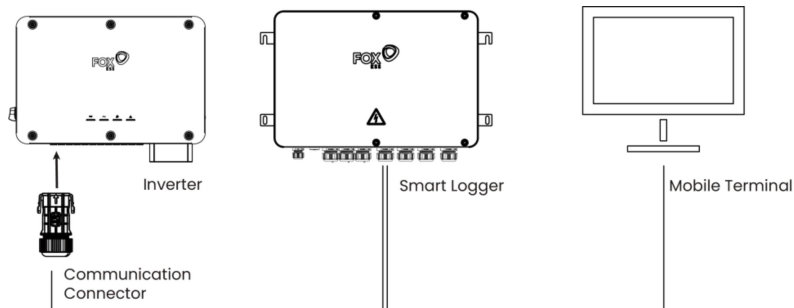

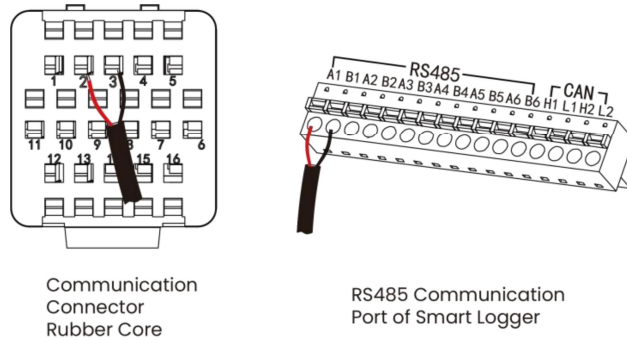

6.6.5.2 Multiple Inverters Communication Wiring

The wiring diagram is shown as below:

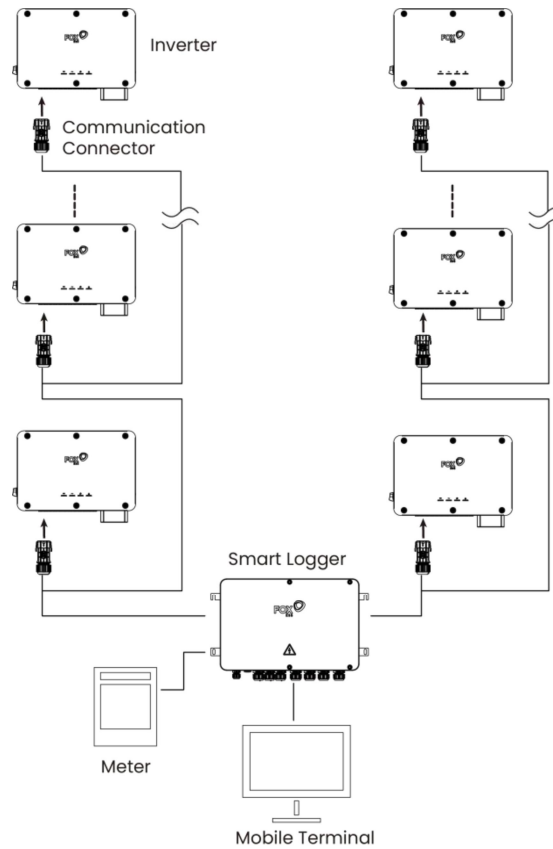

Wire these devices in turn. The detailed wiring diagram of the smart logger and the inverter is shown as below:

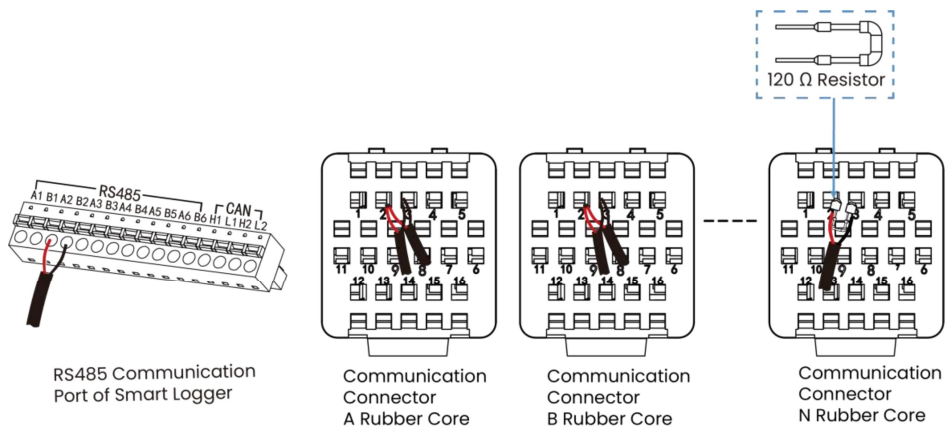



Note!

Connect the smart logger 485A2 terminal with communication connector A terminal 2 via cable and connect the smart logger 485B2 terminal with communication connector A terminal 3 via cable. Connect communication connector A terminal 2 with communication connector B terminal 2 via cable and connect communication connector A terminal 3 with communication connector B terminal 3 via cable. Connect communication connector N terminal 2 and terminal 3 with 120 Ω resistor.

Connect the meter with the RS485 communication port of the smart logger via cable and the detailed wiring diagram is shown as below:

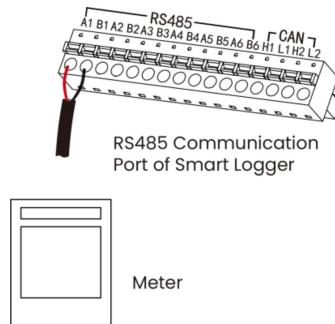

6.6.5.3 Master Inverter & Multiple Slave Inverters Communication Wiring

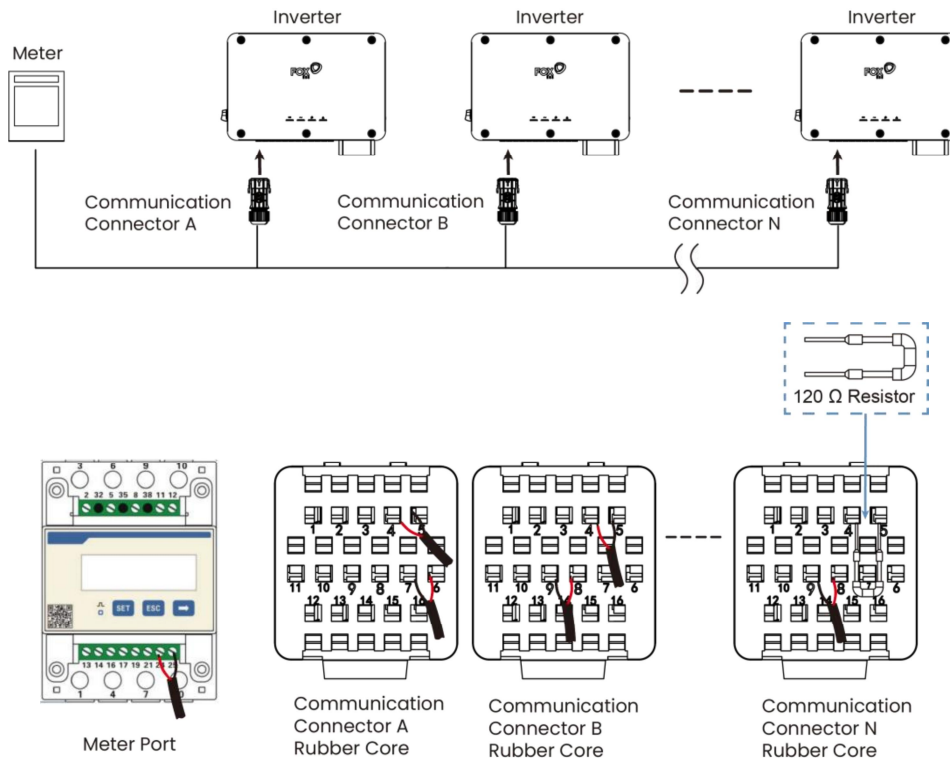

Note!

Connect the meter terminal 24 with communication connector A terminal 6 via cable and connect the meter terminal 25 with communication connector A terminal 7 via cable. Connect

	<p>communication connector A terminal 4 with communication connector B terminal 8 via cable and connect communication connector A terminal 5 with communication connector B terminal 9 via cable. Connect communication connector N terminal 4 and terminal 5 with 120 Ω resistor.</p>
--	--

7. Commissioning

7.1 Inspection before Commissioning

Check the following items before starting the inverter:

- All equipment has been reliably installed.
- DC switch(es) and AC circuit breaker are in the "OFF" position.
- The ground cable is properly and reliably connected.
- The AC cable is properly and reliably connected.
- The DC cable is properly and reliably connected.
- The communication cable is properly and reliably connected.
- The vacant terminals are sealed.
- No foreign items, such as tools, are left on the top of the machine or in the junction box (if there is).
- The AC circuit breaker is selected in accordance with the requirements of this manual and local standards.
- All warning signs & labels are intact and legible.

7.2 Inverter Start-Up

Please refer to the following steps to start up the inverter:

1. Check if device is fixed well on the wall.
2. Make sure all AC circuit breakers are disconnected.
3. Ensure AC cable is connected to the grid correctly.
4. All PV panels are connected to inverter correctly; DC connectors that are not used should be sealed by cover.
5. Connect the external AC circuit breakers.
6. Turn the DC switch to the "ON" position.

If the inverter is not working normally, please check the below:

- All the connections are correct.
- All the external disconnect switches are closed.
- The DC switch of the inverter is in the "ON" position.



Warning!

Power to the unit must be turned on only after installation work has been completed. All electrical connections must be carried out by qualified personnel in accordance with legislation in force in the country of installation.

7.3 Inverter Switch Off

Please follow the below steps to switch off the inverter:

1. Switch off the inverter AC circuit breaker.
2. Turn the inverter DC switch to the "OFF" position.

7.4 Fox Cloud APP

The Fox Cloud App can establish communication connection to the inverter via the monitoring module, thereby achieving near-end maintenance on the inverter. Users can use the App to view basic information, alarms, and events, set parameters, or download logs, etc.

Scan the following QR code to download and install the App according to the prompt

information.





Enter the following link in your browser for the APP user manual.

<https://www.fox-ess.com/download/upfiles/APP%20Fox%20ESS%20Cloud%20English%20User%20Manual.pdf>

8. Maintenance

This section contains information and procedures for solving possible problems with the Fox ESS inverters and provides you with troubleshooting tips to identify and solve most problems that can occur.

8.1 Maintenance Safety

	<p>Danger!</p> <ul style="list-style-type: none">• When maintaining the product, it is strictly prohibited to open the product if there is an odor or smoke or if the product appearance is abnormal.• Be sure to use special insulation tools when perform high-voltage operations.• Before maintenance, disconnect the AC circuit breaker on the grid side and then the DC switch. If a fault that may cause personal injury or device damage is found before maintenance, disconnect the AC circuit breaker and wait until the night before operating the DC switch. Otherwise, a fire inside the product or an explosion may occur, causing personal injuries.• After the inverter is powered off for 15 minutes, measure the voltage and current with professional instrument. Only when there is no voltage nor current can operators who wear protective equipment operate and maintain the inverter.• Even if the inverter is shut down, it may still be hot and cause burns. Wear protective gloves before operating the inverter after it cools down.
	<p>Caution!</p> <p>To prevent misuse or accidents caused by unrelated personnel: Post prominent warning signs or demarcate safety warning areas around the inverter to prevent accidents caused by misuse.</p>
	<p>Note!</p> <ul style="list-style-type: none">• Before handling the product, make sure that the tools you are using have been regularly maintained.• Restart the inverter only after removing the fault that impairs safety performance.• As the inverter contains no component parts that can be maintained, never open the enclosure, or replace any internal components.• To avoid the risk of electric shock, do not perform any other maintenance operations beyond this manual. If necessary, contact your distributor first. If the problem persists, contact Fox ESS. Otherwise, the losses caused are not covered by the warranty.• Touching the PCB or other static sensitive components may cause damage to the device. Do not touch the circuit board unnecessarily. Observe the regulations to protect against electrostatic and wear an anti-static wrist strap.

8.2 Alarm List

Item	Fault Code	Statement	Solution
1	1030	AC Overcurrent	The inverter will reconnect to the grid after the grid is restored. If the fault recurs, please contact Fox ESS Customer Service for further assistance.
2	1034	DC Component Current Fault	Wait for the inverter to return to normal. If the fault recurs, turn off the AC and DC side switches, wait for 10 minutes, and then turn on the AC and DC switches in turn to restart the inverter. If the fault still exists, please contact Fox ESS Customer Service for further assistance.
3	1035	Leakage Current Overcurrent Fault	The fault is caused by excessive parasitic capacitance due to poor light or moist air. After the environment improves, the inverter will reconnect to the grid. If the environment is normal, check whether the insulation of the AC and DC cables is good. If the fault still exists, please contact Fox ESS Customer Service for further assistance.
4	1036	Leakage Current Static Fault	
5	1040	Grid Voltage Imbalance	The inverter will reconnect to the grid after the grid is restored. If the fault recurs: 1. Check whether the protection parameter settings meet the requirements through the APP. 2. Measure the actual grid voltage, confirm that the grid voltage and frequency of each phase do not meet the grid-tied requirements, and contact the local power company for solutions. If the fault still exists, please contact Fox ESS Customer Service for further assistance.
6	1042	Grid High Frequency	
7	1043	Grid Low Frequency	
8	1044	Grid Phase Voltage Exceeds Limit	
9	1045	Grid Line Voltage Exceeds Limit	
10	1046	AC Current Imbalance	

Item	Fault Code	Statement	Solution
11	1049	Capture Phase-Locked Loop Exception	
12	1050	Inverter Hardware Overcurrent	The inverter will reconnect to the grid after the grid is restored. If the fault recurs, please contact Fox ESS Customer Service for further assistance.
13	1051	Grid Voltage Absent	The inverter will reconnect to the grid after the grid is restored. If the fault recurs: 1. Measure the actual grid voltage. 2. Check that the grid voltage and frequency of each phase do not meet the grid-tied requirements, and contact the local power company for solutions. If the fault still exists, please contact Fox ESS Customer Service for further assistance.
14	1057	Bus Transient Overvoltage	Wait for the inverter to return to normal.
15	1065	PV Hardware Overcurrent	If the fault recurs, turn off the AC and DC side switches, wait for 10 minutes, and then turn on the AC and DC switches in turn to restart the inverter. If the fault still exists, please contact Fox ESS Customer Service for further assistance.
16	1070	Bus Voltage Imbalance Fault	Wait for the inverter to return to normal.
17	1071	Bus Hardware Overvoltage	If the fault recurs, turn off the AC and DC side switches, wait for 10 minutes, and then turn on the AC and DC switches in turn to restart the inverter. If the fault still exists, please contact Fox ESS Customer Service for further assistance.
18	1072	PV Access Fault	Wait for the inverter to return to normal. If the fault recurs, turn off the AC and DC side switches, wait for 10 minutes, and then turn on the AC and DC switches in turn to restart the inverter.

Item	Fault Code	Statement	Solution
			If the fault still exists, please contact Fox ESS Customer Service for further assistance.
19	1085	DC Input MPPT1 Access Fault	Check whether the positive and negative polarities of the strings corresponding to the fault are reversed. If the polarities are reversed, adjust the string polarities when the string current is low. If the fault still exists, please contact Fox ESS Customer Service for further assistance.
20	1086	DC Input MPPT2 Access Fault	
21	1088	DC Input MPPT3 Access Fault	
22	1090	Hardware Power Module Fault	Wait for the inverter to return to normal. If the fault recurs, turn off the AC and DC side switches, wait for 10 minutes, and then turn on the AC and DC switches in turn to restart the inverter. If the fault still exists, please contact Fox ESS Customer Service for further assistance.
23	1096	Secondary Chip Fault	
24	1097	12V Auxiliary Power Fault	
25	1098	5V Auxiliary Power Fault	
26	1099	Over-temperature Protection	Check if the inverter is exposed to direct sunlight, please shade the inverter properly. Check and clean the air outlet. Check whether there is a fan alarm through the APP (refer to the solution to the fan alarm). If the fault still exists, please contact Fox ESS Customer Service for further assistance.
27	1102	AC DC Component Sampling Channel Fault	Wait for the inverter to return to normal. If the fault recurs, turn off the AC and DC side switches, wait for 10 minutes, and then turn on the AC and DC switches in turn to restart the inverter. If the fault still exists, please contact Fox ESS Customer Service for further assistance.
28	1103	AC Current Sampling Channel Fault	
29	1106	Inverter Soft Start Timeout Fault	
30	1107	Bus Soft Start Fault	

Item	Fault Code	Statement	Solution
31	1108	Grid Frequency Detection Fault	<p>The inverter will reconnect to the grid after the grid is restored.</p> <p>If the fault recurs:</p> <ol style="list-style-type: none"> 1. Check whether the protection parameter settings meet the requirements through the APP. 2. Measure the actual grid voltage, confirm that the grid voltage and frequency of each phase do not meet the grid-tied requirements, and contact the local power company for solutions. <p>If the fault still exists, please contact Fox ESS Customer Service for further assistance.</p>
32	1109	Leakage Current CT Self-Test Fault	<p>Wait for the inverter to return to normal.</p> <p>If the fault recurs, turn off the AC and DC side switches, wait for 10 minutes, and then turn on the AC and DC switches in turn to restart the inverter.</p> <p>If the fault still exists, please contact Fox ESS Customer Service for further assistance.</p>
33	1112	System Fault	<p>If the fault still exists, please contact Fox ESS Customer Service for further assistance.</p>
34	1116	Ground Impedance Fault	<p>Check if the ground cables are connected properly.</p> <p>Check if the insulation between the ground cable and the live cable is good.</p> <p>If the fault still exists, please contact Fox ESS Customer Service for further assistance.</p>
35	1123	Grid-Side Relay Fault	<p>Wait for the inverter to return to normal.</p> <p>If the fault recurs, turn off the AC and DC side switches, wait for 10 minutes, and then turn on the AC and DC switches in turn to restart the inverter.</p> <p>If the fault still exists, please contact Fox ESS Customer Service for further assistance.</p>
36	1124	Low Insulation Impedance Fault	<p>Wait for the inverter to return to normal.</p> <p>If the fault recurs:</p>

Item	Fault Code	Statement	Solution
			<p>1. Check whether the ISO impedance protection value meets the local regulations through the APP.</p> <p>2. Check whether the DC cable and ground contact are good.</p> <p>If the cable is normal and the fault occurs on a cloudy or rainy day, check again when the weather gets better.</p>
37	1129	Inverter Open-Loop Self-Test Fault	<p>Wait for the inverter to return to normal.</p> <p>If the fault recurs, turn off the AC and DC side switches, wait for 10 minutes, and then turn on the AC and DC switches in turn to restart the inverter.</p> <p>If the fault still exists, please contact Fox ESS Customer Service for further assistance.</p>
38	1144	AFCI Self-Test Fault	<p>1. Disconnect the DC input, check whether there are damaged cables, loose terminals or fuses, and burn marks on components on the DC side.</p> <p>2. Reconnect the DC input and clear the arc fault through the APP to make the inverter return to normal.</p> <p>If the above reasons are excluded and the alarm still exists, please contact Fox ESS Customer Service for further assistance.</p>
39	1145	AFCI Fault	
40	1154	AC Overcurrent Permanent Fault	<p>Turn off the AC and DC side switches, wait for 10 minutes, and then turn on the AC and DC switches in turn to restart the inverter.</p> <p>If the fault still exists, please contact Fox ESS Customer Service for further assistance.</p>
41	1157	Relay Permanent Fault	
42	1160	Inverter Open-Loop Self-Test Permanent Fault	
43	1173	System Permanent Fault	
44	1174	Bus Hardware Overvoltage Permanent Fault	
45	1176	PV Hardware Overcurrent Permanent Fault	

Item	Fault Code	Statement	Solution
46	1177	Leakage Current Permanent Fault	
47	1178	Bus Overvoltage Permanent Fault	
48	1179	Bus Voltage Imbalance Permanent Fault	
49	1180	Auxiliary Current Permanent Fault	
50	1181	AFCI Permanent Fault	
51	1185	Grid Startup Voltage Abnormal	<p>The inverter will reconnect to the grid after the grid is restored.</p> <p>If the fault recurs:</p> <ol style="list-style-type: none"> 1. Check whether the protection parameter settings meet the requirements through the APP. 2. Measure the actual grid voltage, confirm that the grid voltage and frequency of each phase do not meet the grid-tied requirements, and contact the local power company for solutions. <p>If the fault still exists, please contact Fox ESS Customer Service for further assistance.</p>
52	1188	AC Side Surge Protector Alarm	Check the status of the SPD, and contact Fox ESS Customer Service for further assistance.
53	1189	DC Side Surge Protector Alarm	
54	1190	Temperature Sensor Alarm	If the ambient temperature is within the inverter operating temperature range and the alarm still exists, please contact Fox ESS Customer Service for further assistance.
55	1191	External Fan Alarm	Check whether the fan is blocked by foreign objects and remove the foreign objects. Please contact Fox ESS Customer Service for further assistance.
56	1192	Internal Fan Alarm	

Item	Fault Code	Statement	Solution
57	1193	Ext-Mem Read-Write Alarm	The internal communication is abnormal. If desired, turn off the AC and DC side switches, wait for 10 minutes, and then turn on the AC and DC switches in turn to restart the inverter. If the alarm still exists, please contact Fox ESS Customer Service for further assistance.
58	1281	Communication Fault between Communication Board and Main DSP	1. Turn off the AC output switch, DC input switch, and battery switch in order, and then turn on the battery switch, AC output switch, and DC input switch in sequence after 2 minutes. 2. If the fault still exists, contact your installer.
59	1282	Communication Fault between Communication Board and Auxiliary DSP	
60	1285	Communication Fault between Communication Board and External Meter	Check whether the RS485 communication cables between the FOX Inverter and the Grid Meter are properly connected.
61	1286	Communication Board Flash Write Fault	1. Turn off the AC output switch, DC input switch, and battery switch in order, and then turn on the battery switch, AC output switch, and DC input switch in sequence after 2 minutes. 2. If the fault still exists, contact your installer.
62	1287	RTC Read/Write Fault	
63	1291	Master-Slave Communication Fault	Check whether the RS485 communication cables of the Master to Slave are properly connected.
64	1292	Meter CT Fault	Check whether the CT cables of the Meter are properly connected.
65	1293	Meter Voltage Fault	Check whether the voltage cables of the Meter are properly connected.
66	1313	DC Input MPPT1 Voltage High Fault	Wait for the inverter to return to normal. If the fault still exists, please contact Fox ESS Customer Service for further assistance.
67	1314	DC Input MPPT2 Voltage High Fault	

Item	Fault Code	Statement	Solution
68	1315	DC Input MPPT3 Voltage High Fault	
69	1316	DC Input MPPT4 Voltage High Fault	
70	1317	DC Input MPPT5 Voltage High Fault	
71	1318	DC Input MPPT6 Voltage High Fault	
72	1325	DC Input MPPT4 Access Fault	<p>Check whether the positive and negative polarities of the strings corresponding to the fault are reversed. If the polarities are reversed, adjust the string polarities when the string current is low.</p> <p>If the fault still exists, please contact Fox ESS Customer Service for further assistance.</p>
73	1326	DC Input MPPT5 Access Fault	
74	1327	DC Input MPPT6 Access Fault	
75	1345	String 1 Abnormal Alarm	<p>1. Confirm whether the Xth MPPT is connected reliably. If no connection is required, ignore this alarm message.</p> <p>2. Check whether the Xth MPPT DC fuse is damaged and replace the fuse in time.</p> <p>3. If the above reasons are excluded and the fault still exists, please contact Fox ESS Customer Service for further assistance.</p>
76	1346	String 2 Abnormal Alarm	
77	1347	String 3 Abnormal Alarm	
78	1348	String 4 Abnormal Alarm	
79	1349	String 5 Abnormal Alarm	
80	1350	String 6 Abnormal Alarm	
81	1351	String 7 Abnormal Alarm	
82	1352	String 8 Abnormal Alarm	
83	1353	String 9 Abnormal Alarm	
84	1354	String 10 Abnormal Alarm	

Item	Fault Code	Statement	Solution
85	1355	String 11 Abnormal Alarm	
86	1356	String 12 Abnormal Alarm	
87	1377	Anti-PID Software Overvoltage	<p>Wait for the inverter to return to normal.</p> <p>If the fault recurs, turn off the AC and DC side switches, wait for 10 minutes, and then turn on the AC and DC switches in turn to restart the inverter.</p> <p>If the fault still exists, please contact Fox ESS Customer Service for further assistance.</p>
88	1378	Anti-PID Software Overcurrent	
89	1379	Anti-PID Hardware Overvoltage	
90	1380	Anti-PID Hardware Overvoltage	

8.3 Troubleshooting

- A. Please check the fault code of the inverter on the APP or website. If a message is displayed, record it before doing anything further.
- B. Attempt the solution indicated in table above.
- C. If the inverter LEDs are not on, check the following to make sure that the current state of the installation allows for proper operation of the unit:
 - Is the inverter located in a clean, dry, adequately ventilated place?
 - Have the DC input breakers opened?
 - Are the cables adequately sized?
 - Are the input and output connections and wiring in good condition?
 - Are the configurations settings suitable for your particular installation?
 - Are the display panel and the communications cable properly connected and undamaged?

Contact Fox ESS Customer Service for further assistance. Please be prepared to describe details of your system installation and provide the model and serial number of the unit.

8.4 Routine Maintenance

A. Safety Check

A safety check should be performed at least every 12 months by a qualified technician who has adequate training, knowledge and practical experience to perform these tests. The data should be recorded in an equipment log. If the inverter is not functioning properly or fails any of the tests, the inverter has to be repaired. For safety check details, refer to Chapter 2 of this manual.

B. Maintenance Checking List

During the process of using the inverter, the responsible person shall examine and maintain the machine regularly. The required actions are as follows:

Checking List	Checking Method	Maintenance Period
System Cleaning	Check whether there are dust and other blockades at the air outlet and heat sink. If necessary, clean the air outlet and heat sink.	Once half a year to a year (Depending on ambient dust content)
Fan	Check whether the fan makes abnormal noise when it is running and whether the fan blade is cracked. If necessary, change the fan.	Once a year
Cable Inlet Holes	Check whether the cable inlet hole of the device is partially blocked or the gap is large. If yes, perform supplementary sealing.	Once a year
Electrical Connection	Check whether cables are loose. Check whether the cable is damaged, especially whether the part of the cable in contact with the metal shell is cut.	Once half a year to a year

Note: Only qualified individuals may perform these actions.

C. Fan Maintenance

The inverter's built-in fan cools and dissipates heat during its operation. If the fan does not work properly, the inverter cannot be effectively cooled, which will affect the efficiency of the inverter or cause derating operation. Therefore, it is necessary to keep the fan clean and replace the damaged fan in time.

The steps to clean and replace the fan are as follows:

- Before fan maintenance begins, be sure to power down the inverter and disconnect all power inputs to the inverter.
- After the inverter is powered down for 15 minutes, use the detection equipment for check to ensure that there is no voltage and current, and wear protective equipment to operate and maintain the inverter.
- Loosen the screws on the fan cover of the case.
- Loosen the fan tray retention screws, unplug the connector cable and pull out the fan, use a soft-bristled brush or vacuum cleaner to clean the fan or replace a damaged fan.
- Fan maintenance must be done by professional personnel.

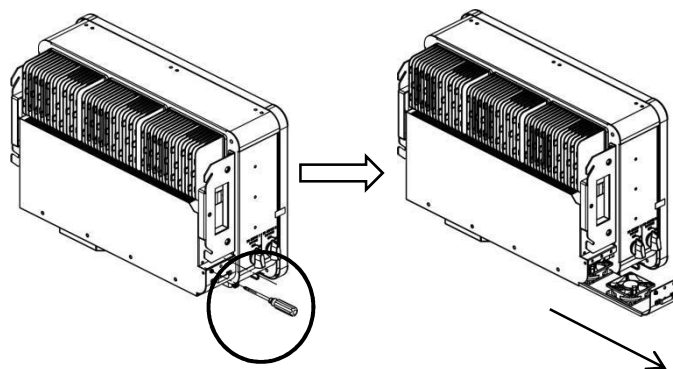

9. Decommissioning

9.1 Dismantling the Inverter

- Disconnect the inverter from DC Input and AC output. Wait for 15 minutes for the inverter to fully de-energize.
- Disconnect communication and optional connection wirings. Remove the inverter from the bracket.
- Remove the bracket if necessary.

9.2 Packaging

If possible, please pack the inverter with the original packaging. If it is no longer available, you can also use an equivalent box that meets the following requirements.

- Suitable for loads more than 55kg.
- Contains a handle.
- Can be fully closed.

9.3 Storage and Transportation

Store the inverter in dry place where ambient temperatures are always between -40°C ~ $+70^{\circ}\text{C}$. Take care of the inverter during the storage and transportation; Keep less than 4 cartons in one stack. When the inverter or other related components need to be disposed, please ensure it is carried out according to local waste handling regulations.

The copyright of this manual belongs to FOXESS CO., LTD. Any corporation or individual should not plagiarize, partially or fully copy (including software, etc.), and no reproduction or distribution of it in any form or by any means is permitted.

All rights reserved.

FOXESS CO., LTD.

Add: No. 939, Jinhai Third Road, New Airport Industry Area, Longwan District, Wenzhou, Zhejiang
Province, China

Tel: 0510-68092998

WWW.FOX-ESS.COM